

Research and Implementation on Intent-Driven Network

**Intent-Driven Network (IDN) / Intent-Based Network (IBN)
A Network of Networks for Autonomous Driving Network**

Chungang Yang

Ying Ouyang, Yanbo Song, Xinru Mi

Xidian University

guideyang2050@163.com

2022.06

The National Key Research and Development Program of China (2020YFB1807700).

Content

- 1 Motivation**
- 2 Architecture and Technology**
- 3 Intent Refinement**
- 4 Intent Automation**
- 5 Intent Verification**
- 6 Summary**

1.Motivation

Novel Challenges [Service as you want, network as you demand, resources as you wish]

Complex and huge networks, with various service requirements, Flexibility, Robustness, Security, and Smart; and thus motivate AI, SDN, ICN, NFV, 6G, Satellites...Content, Semantic, Intent.....Zero-Touch Service and Network Management...Autonomous Driving Network

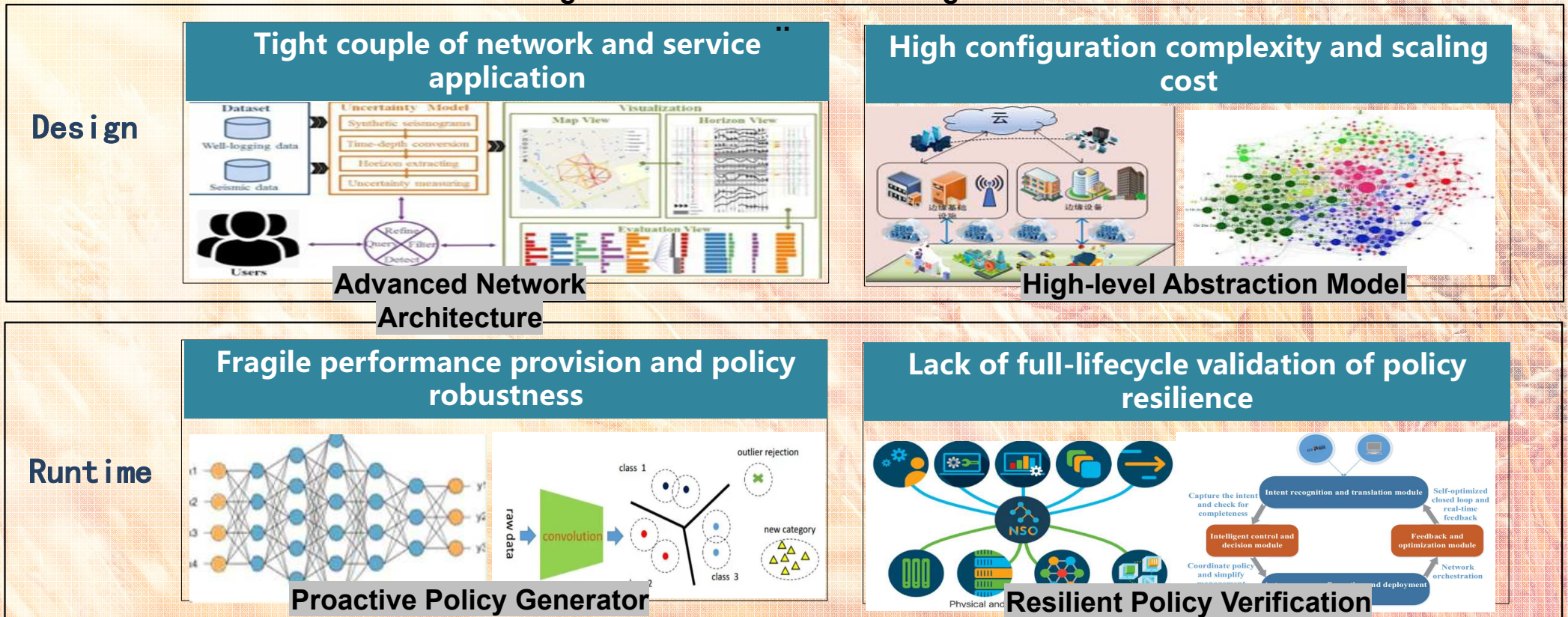

Chungang Yang, Xinru Mi, Ying Ouyang , et al. : SMART Intent-Driven Network Management, IEEE CM 2022-3-27, Under Review.
SMART=Specific Measurable Achievable with Rewarding and Time-bound

1. Motivation

□ Novel Challenges [Basic model, and detailed policy design and implementation]

1

SNMP (Simple Network Management Protocol)

The first network management techniques for small-scale networks focus on the **configuration details** of network devices. [Device-Oriented with CLI]

2

PBNM (Policy-Based Network Management)

It can transform business requires and processes into **policies** that efficiently configure and control networks. [Policy-Based with ECA Template]

- **Manual: Configuraton automatic** [No Reactive]
- **Policy: Policy-based autonomic** [Reactive]
- **Intent: Intent-driven autonomous** [Proactive]

3

IDNM (Intent-Driven Network Management)

IDNM is an **evolution** of PBNM in management mode and theory. Meanwhile, IDNM is an evolution of SDNs and NFV in terms of network architecture and key technologies.

[Intent-Driven with NLP or AI as Service]

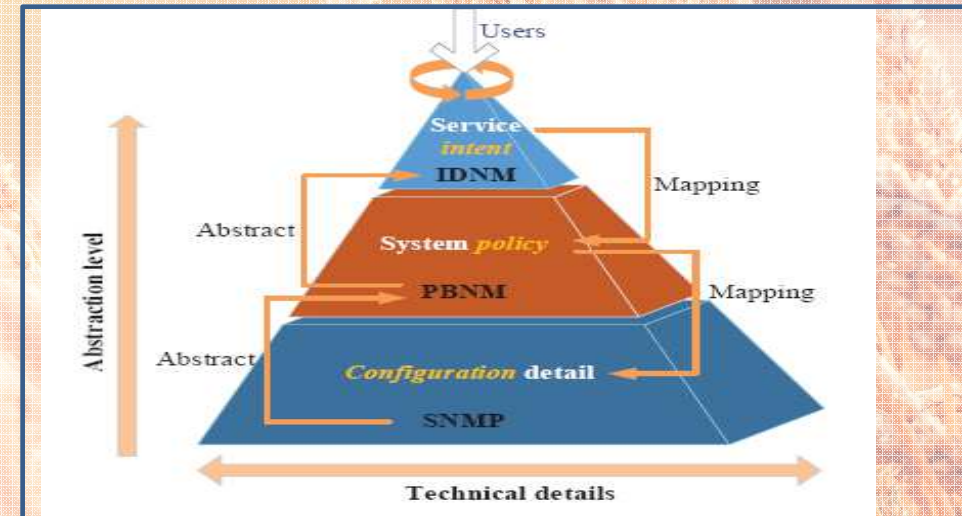

1.2. Three Levels of Communications Problems

Relative to the broad subject of communication, there seem to be problems at three levels. Thus it seems reasonable to ask, serially:

LEVEL A. How accurately can the symbols of communication be transmitted? (The technical problem.)

LEVEL B. How precisely do the transmitted symbols convey the desired meaning? (The semantic problem.)

LEVEL C. How effectively does the received meaning affect conduct in the desired way? (The effectiveness problem.)

1.Motivation

□ State of the Art [Intent UI@Mobile Communication Systems, and SDN NBI]

- 1 ETSI ENI** ● Intent is regarded as Policy in the ENI system. High-level and declarative.
- 2 3GPP SA5** ● Intent driven management services for mobile networks, define Intent-CSC, Intent-CSP, and Intent-NOP.
- 3 ETSI ZSM** ● Research on zero-touch network; Intent-driven methodology is introduced as basis for policy-driven and describes the network requirements from a high abstraction level.
- 4 IETF NMRG** ● NRMG clarifies the intent concept and classification, introduces PBNM, and defines the Intent lifecycle.
- 5 IETF ANIMA** ● Research on the "automatic network management and control method formed by intents of autonomous nodes" from the control plane of autonomous nodes.
- 6 tmforum** ● Research on the automation network level while pointing out that IDN meets the design goals of L0-L5.
- 7 CCSA TC3WG1** ● Started research on IBN in 2019, including network intelligence classification, key technology requirements, and application scenarios.
- 8 ONAP Guilin** ● Intent framework is introduced based on the policy framework OOF. It also introduces Intent verification and Intent assurance function, and formulates IDN as a potential tool for 5G network slicing.



Level

LCM

Interface

Definition

Classification

Deployment



2. Architecture and Technology

OLF NETWORKING
LFN Developer & Testing Forum

Generic Architecture of IDN [Decouple, Intent Engine]

- The application layer collects the intent, the intent-enabled layer refines the intent to network policy and configurations, and the infrastructure layer implements the configurations.

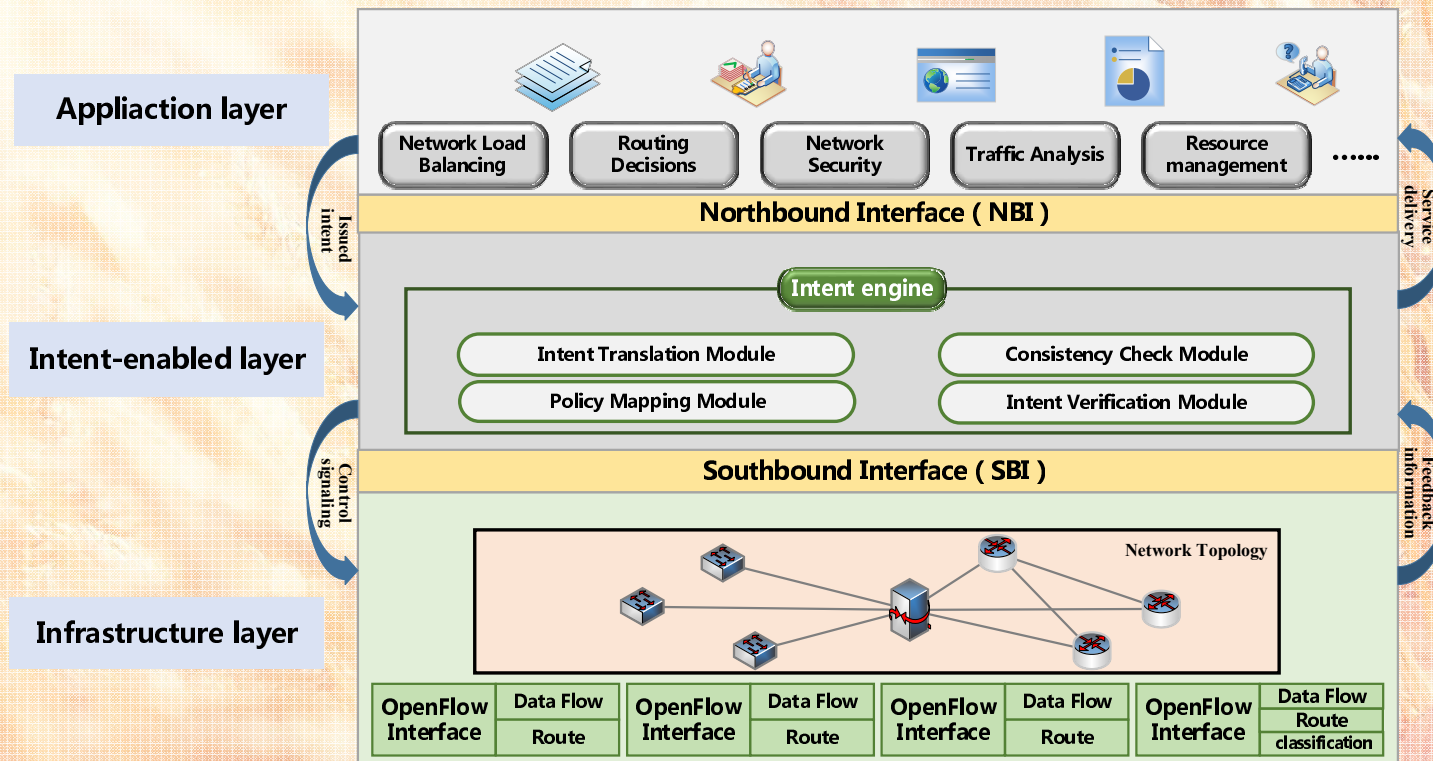

Ying Ouyang, Chungang Yang, Yanbo Song, et al. : A Brief Survey and Implementation on Refinement for Intent-Driven Networking, IEEE Network, 2021, 35(6): 75-83.

2. Architecture and Technology

Generic Implementation of IDN

- There exist four forms of intent in the generic implementation process of IDN, mainly comprising **the input intent, the valid intent, the identifiable network intent, and the device configurations.**
- Intent can be input via the voice interface or the webpage, and finally formulated the network policy deployed to the infrastructure layer by a standard interface (i.e., the OpenFlow protocol).

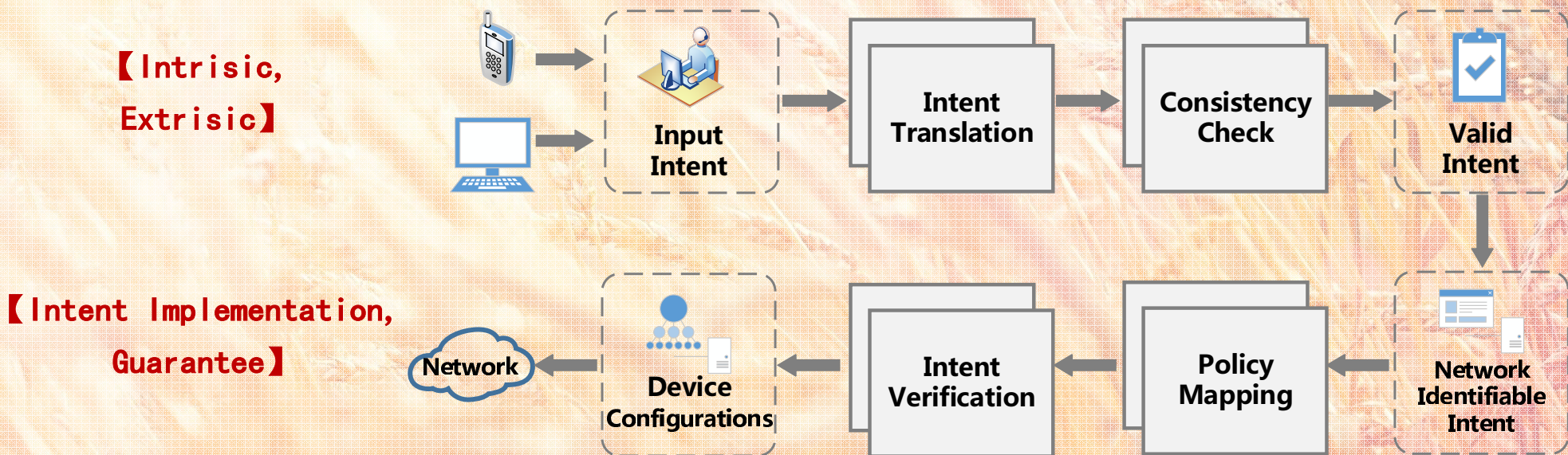

3.Intent Refinement

Classification of intent refinement • Intent Refinement: syntax and semantic

➤ Intent refinement can be classified in terms of the following aspects, respectively, the target users, the input methods, and the refinement schemes.

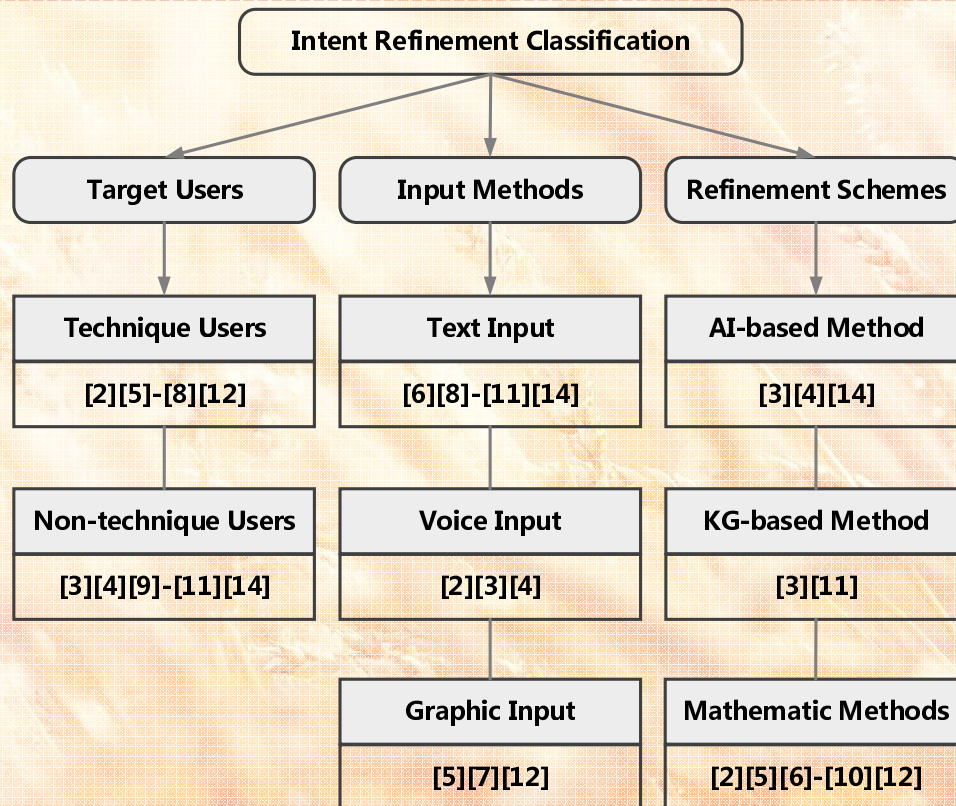

Main References

- [2] A. Chaudhari, A. Asthana, A. Kaluskar, D. Gedia, L. Karani, L. Perigo, R. Gandotra, and S. Gangwar, "Vivonet: Visually represented, intent-based, voice-assisted networking." CoRR, vol. abs/1904.03228, 2019.
- [3] H. Mahtout, M. Kiran, A. Mercian, and B. Mohammed, "Using machine learning for intent-based provisioning in high-speed science networks," in Proceedings of the 3rd International Workshop on Systems and Network Telemetry and Analytics, pp. 27–30, 2020.
- [4] A. S. Jacobs, R. J. Pfitscher, R. A. Ferreira, and L. Z. Granville, "Refining network intents for self-driving networks," in Proceedings of the Afternoon Workshop on Self-Driving Networks, SelfDN@SIGCOMM 2018, Budapest, Hungary, August 24, 2018, pp. 15–21, ACM, 2018.
- [5] C. Prakash, J. Lee, Y. Turner, J. Kang, A. A. andservice Sujata Banerjee, C. Clark, Y. Ma, P. Sharma, and Y. Zhang, "PGA: using graphs to express and automatically reconcile network policies," in Proceedings of the 2015 ACM Conference on Special Interest Group on Data Communication, SIGCOMM 2015, London, United Kingdom, August 17-21, 2015 (S. Uhlig, O. Maennel, B. Karp, and J. Padhye, eds.), pp. 29–42, ACM, 2015.
- [6] P. Widmer and B. Stiller, Design and Implementation of an Intent-based Blockchain Selection Framework. PhD thesis, Master's thesis, University of Zurich, 2020.
- [10] P. Sköldström, S. Junique, A. Ghafoor, A. Marsico, and D. Siracusa, "Dismi-an intent interface for application-centric transport network services," in 2017 19th International Conference on Transparent Optical Networks (ICTON), pp. 1–4, IEEE, 2017.

3.Intent Refinement

Implementation Platform on Intent Refinement

- Non-technical intent can be input in natural language, and technical intent can be input based on reference parameters.
- The framework of our **intelligent intent refinement system** is composed of three parts: the intent GUI front-end, the intent refinement schedule system, and the multi-domain network.

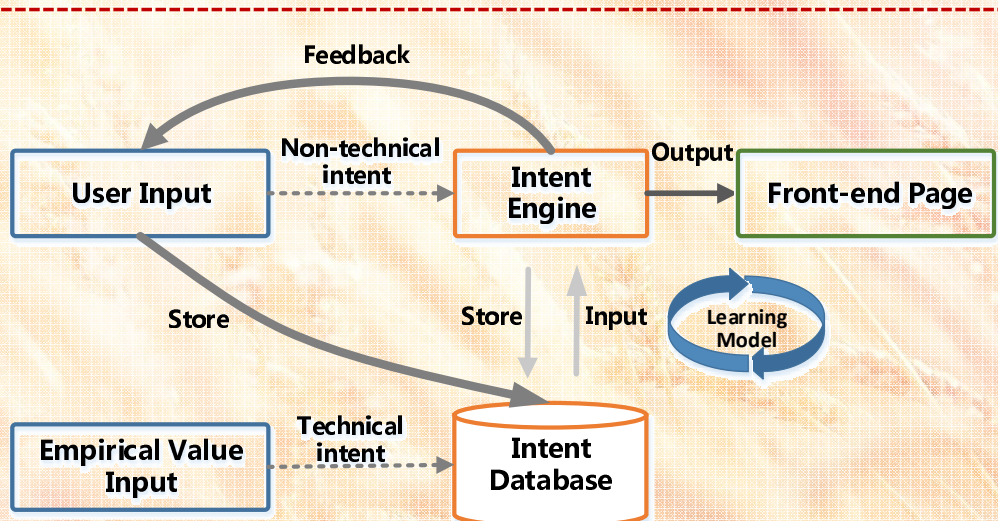

- The intelligent intent refinement system is designed to realize two kinds of services, respectively, establishing a link service and adjusting a link service.

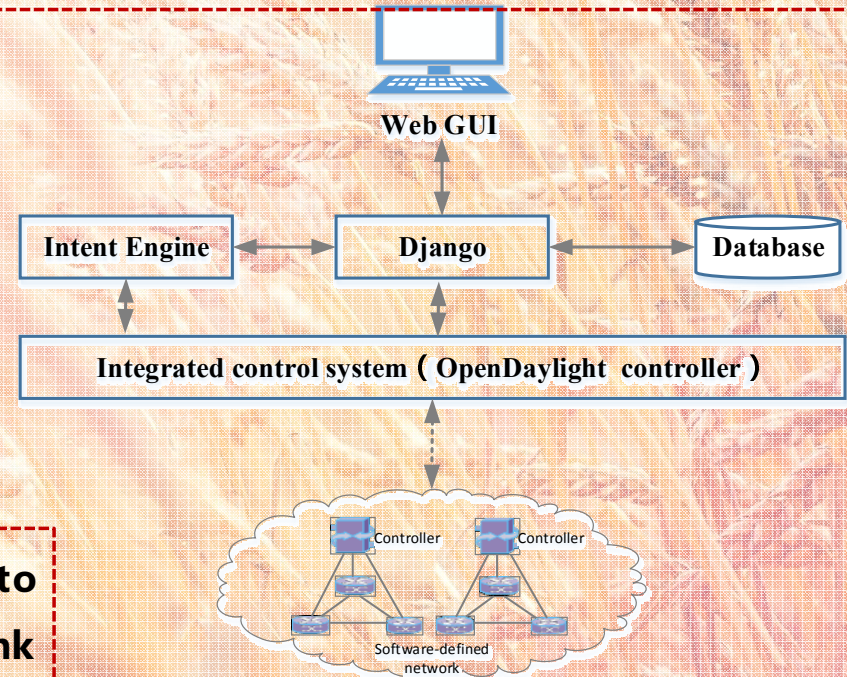

3.Intent Refinement

Implementation Platform on Intent Refinement

- The **training time** of the refinement datasets increases with dataset size.
- The **refinement accuracy** can be improved by using a larger dataset, and wonderful results can be obtained with 20000 entries.
- The BiLSTM-CRF method is superior to the LSTM-CRF method in terms of the accuracy, as it can extract information of intent forward and backward.

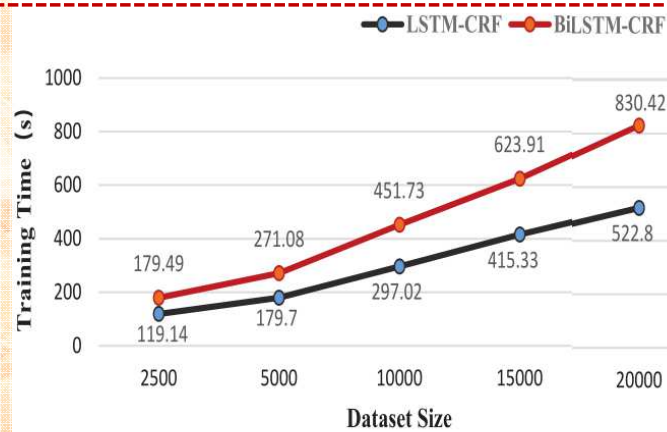

(a) Training time

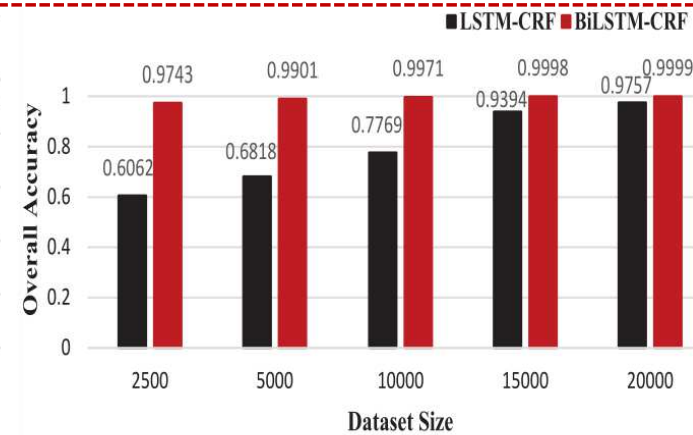

(b) Refinement accuracy

- After intent refinement, machine readable types of designed formatted intent, and then motivates the following autonomous intent-driven policy generator, where refined intent as an event (Intent Automation)

4.Intent Automation

Implementation Platform on Autonomous Policy Generation 【Logical, Physical】

- Belief-Desire-Intention (BDI) is a theory that replicates human decision-making. The three states of BDI are incorporated into fundamental logical predicates to represent state of reasoning.
- The events are published from network with the event monitor and the anomaly detection. The resilience policy will be sent to network by action executor and upload to blockchain to storage and domain controller.

BDI Model as Logic

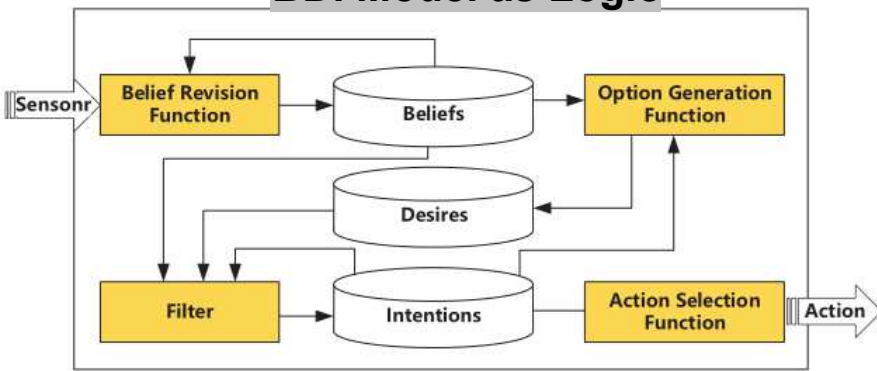

Proactive Policy Generator

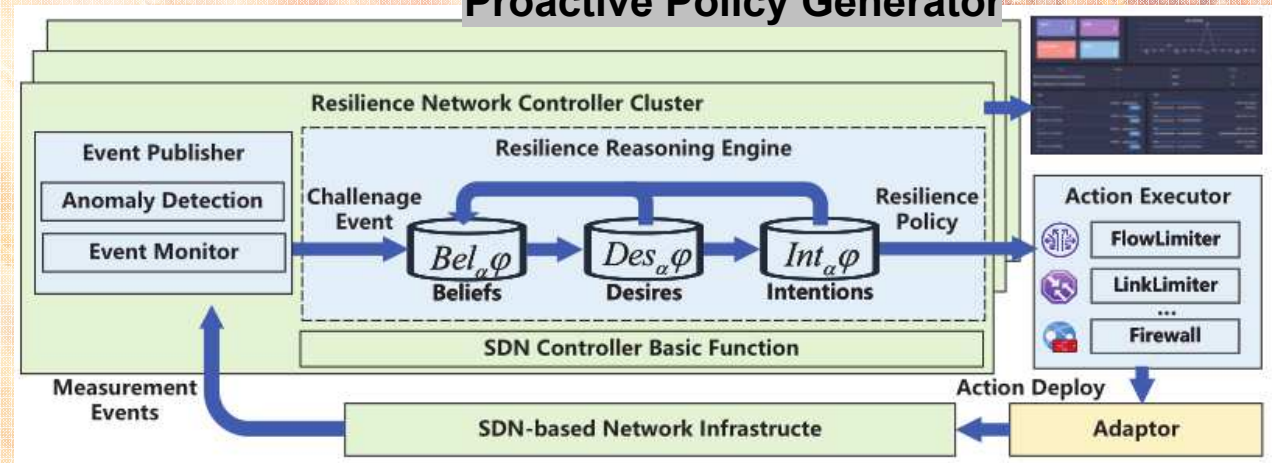

Yanbo Song, Xianming Gao, Pengcheng Li, Chungang Yang, Resilience Network Controller Design for Multi-Domain SDN: A BDI-based Framework. IEEE VTC 2022

4.Intent Automation

Implementation Platform on Autonomous Policy Generation

- To construct a safe and dependable defensive plan, network events are monitored in real time and the BDI reasoning module controls Link, IP, and Flow to ensure that the network remains available at all times.
- Consider DDoS defense: when network traffic spikes, network events are monitored in real time, and the BDI reasoning module controls Link, IP, and Flow to ensure that the network is always available.

$event(anomalousUsage(link))$

$BEL_{\alpha}(anomalousUsage(link))$

$DES_{\alpha}(reCover(link)) \wedge DES_{\alpha}(attackPrevent(link))$

$INT_{\alpha}(Linklimter(link)) \vee INT_{\alpha}(IPlimter) \vee INT_{\alpha}(Flowlimter)$

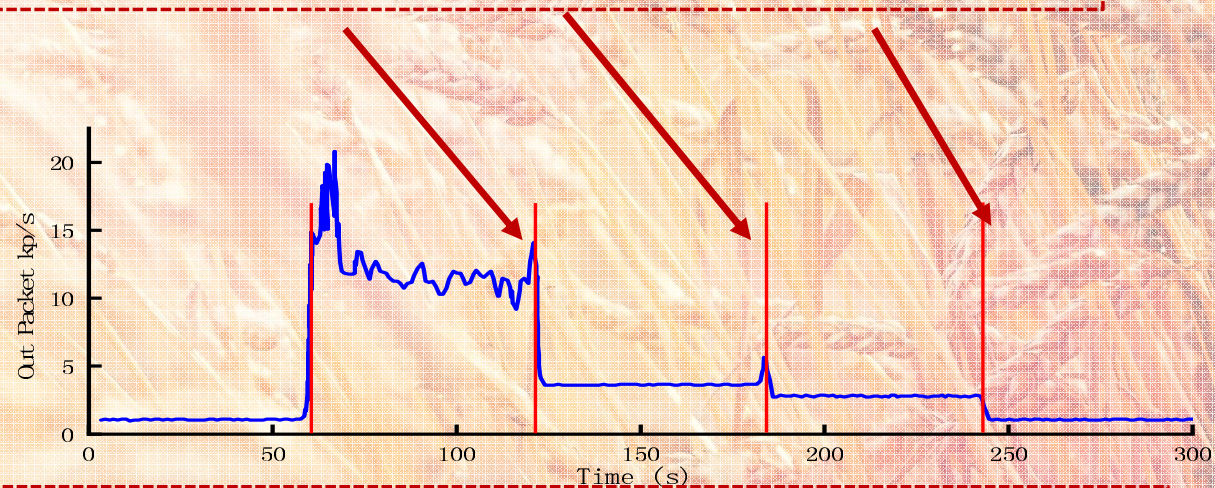

- After Proactive Policy Generator, we can achieve the logical or the potential policy repository.

5.Intent Verification

Implementation Platform on Intent Verification

【Logical, Physical】

- The form of intent is continually changing and translating. Each translation introduces some "distortion" as a result of lower-level limitations, therefore the intent must be validated at each stage to verify that it remains correct throughout the continuous translation.
- The expression forms of intents are given from the network and language perspective, and the typical technical examples for translation are given between different intent from.

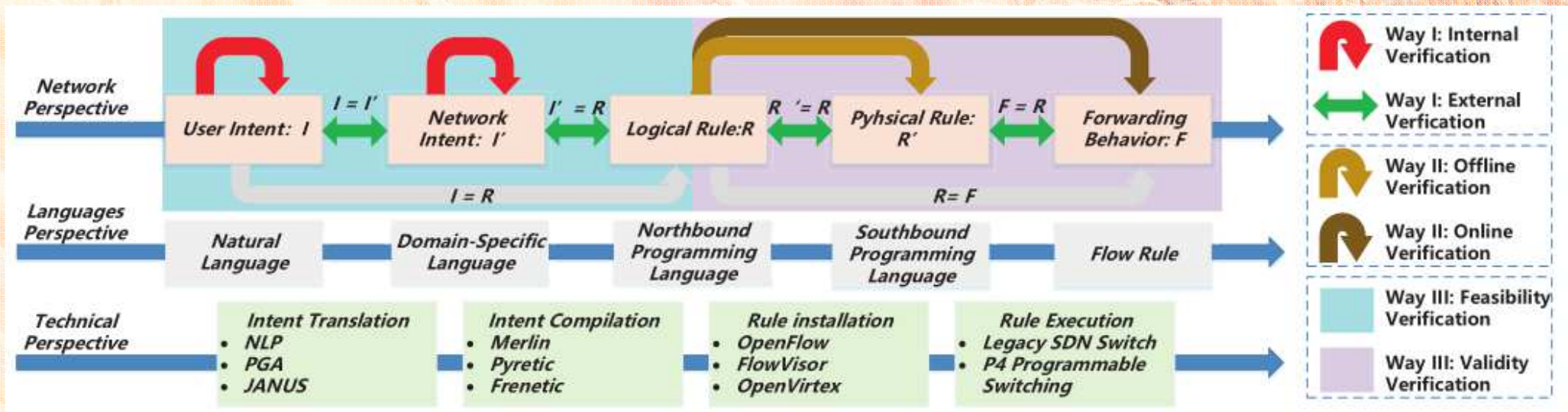

Yanbo Song, Chungang Yang , et al. : Full-Life Cycle Intent-Driven Network Verification: Challenges and Approaches, IEEE Network, Major Revision.

5.Intent Verification

Implementation Platform on Intent Verification

【Logical, Physical】

- Full-life cycle intent-driven network verification framework. The verification module is deployed in the control layer, which is connected to the application layer and switches through north and south interfaces.
- The intent verification framework proposed in this article realizes the full-life cycle verification of intent, which can be used as a basic framework in developing IDN.

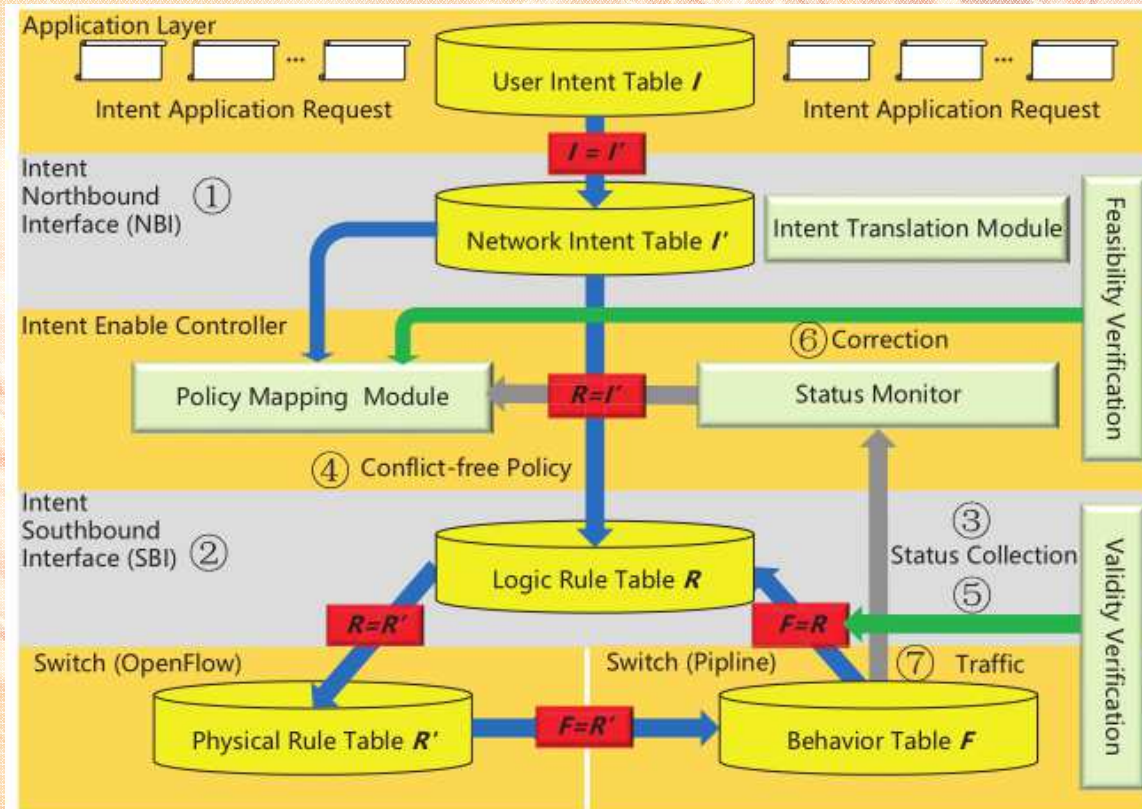

Resilient Policy Verification

5.Intent Verification

Implementation Platform on Intent Verification

- We create 100 to 500 intent application requests and the intent verification module collects the intent, we realize the intent feasibility verification through graph combination. Endpoints represent a group of users or network services. The text represents the port number and other attributes, such as bandwidth or network functions LB, IDS, Web, DDoS.
- Since the intent application requests come from different endpoint groups, they may have conflicts. The primary purpose of verification is to ensure conflict-free merging between multiple intents.

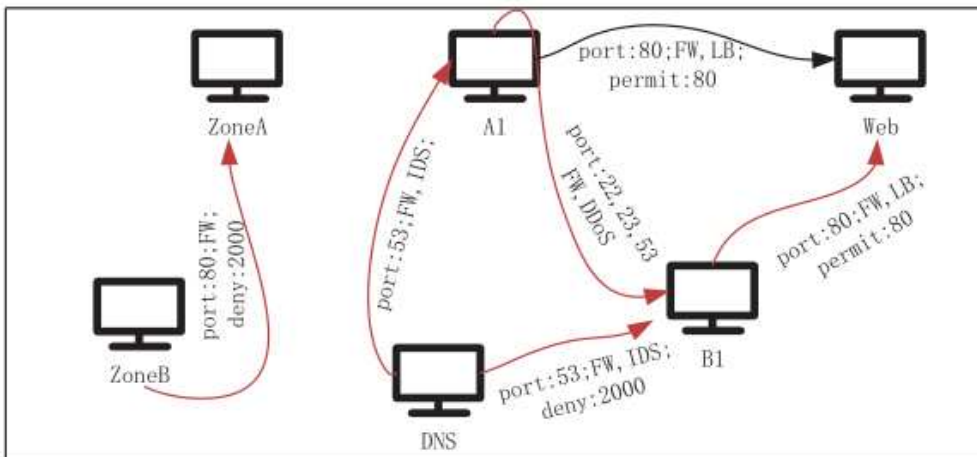

(a) Conflict-free policy in graph.

```
If_(match(srcip=ZoneB, dstport=80, dstip=ZoneA))
if_(match(srcip=DNS, dstport = 53, dstip = A1)), FW >> IDS
if_(match(srcip=A1, dstport=22 23 53, dstip=B1)), FW>>DDoS
if_(match(srcip=A1, dstport=80, dstip=Web)), FW>>LB
if_(match(srcip=DNS, dstport=53, dstip=B1), FW>>IDS
if_(match(srcip=B1, dstport=80, dstip=Web)), FW>>LB
```

(b) Conflict-free policy in Pyretic.

5.Intent Verification

Implementation Platform on Intent Verification

- When there are 100-500 intents, the delay is within 300-1160 ms and the cumulative distribution function (CDF) of verification time is relatively concentrated, which means a relatively stable effect.
- It can be seen that our verification engine can better realize the conflict detection and decomposition of multi-user input intents.

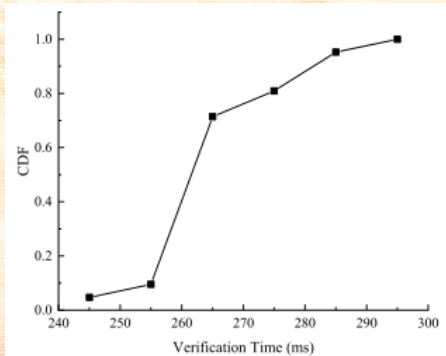

The CDF of verification time for 100 intents.

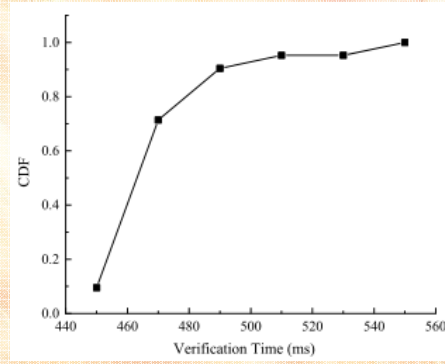

The CDF of verification time for 200 intents.

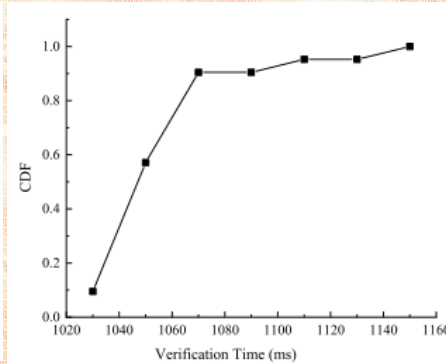

The CDF of verification time for 500 intents.

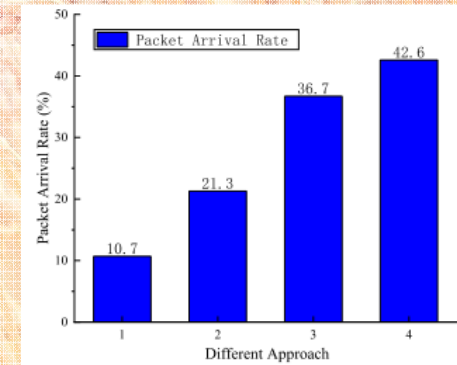

Packet arrival rate with different approach.

6.Summary

Intent Refinement, Logical Policy Automation, Full-life Verification for Physical Actions

Semantic-Aware Intent-Driven Network; Network Digital Twin; Dynamic Knowledge Graph.

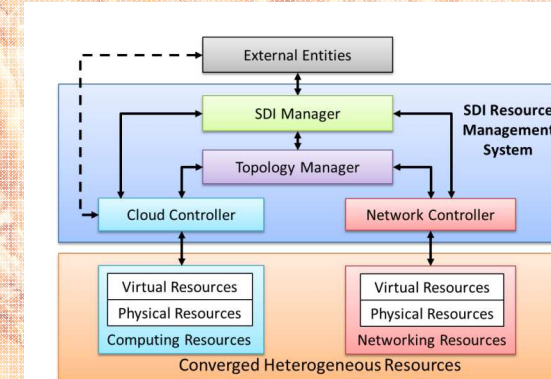
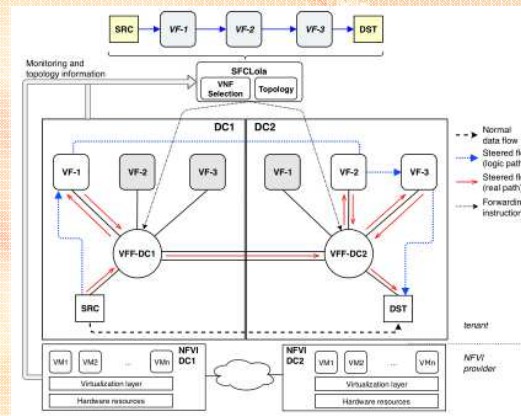
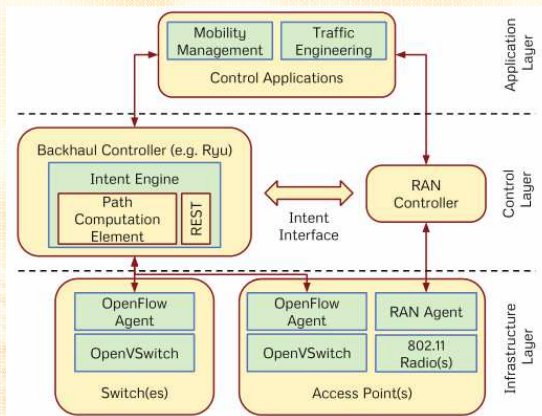

- Flexibility and customization services;
- Integrated network architecture;
- Open and programmable protocol;
- Flexible and reconfigurable resources;
- Autonomous and much more intelligent network management methods.

- Refine the intents from both the syntax and the semantic perspectives;
- Perceive network status;
- Achievable configuration decisions.

- More Wider applications as IDN Methodology

Many Thanks Indeed.

**Research and Implementation
on Intent-Driven Network**

Chungang Yang

Ying Ouyang, Yanbo Song, Xinru Mi

Xidian University

guideyang2050@163.com

2022.06