

Overall E2E Network Slicing Modeling Design for G&H

Chuyi Guo, CMCC

guochuyi@chinamobile.com

2021.02

- Model Design Principle
 - ONAP SDO specifications mapping
 - ONAP model conceptions
 - Design time template structure in Guilin
- AAI Instance Modeling
 - Snapshot of full instance models
 - Transport slicing model
 - EP: Solution for 3 subnets interworking
- H Release enhancement

Model Design Principle

ONAP SDO specifications mapping

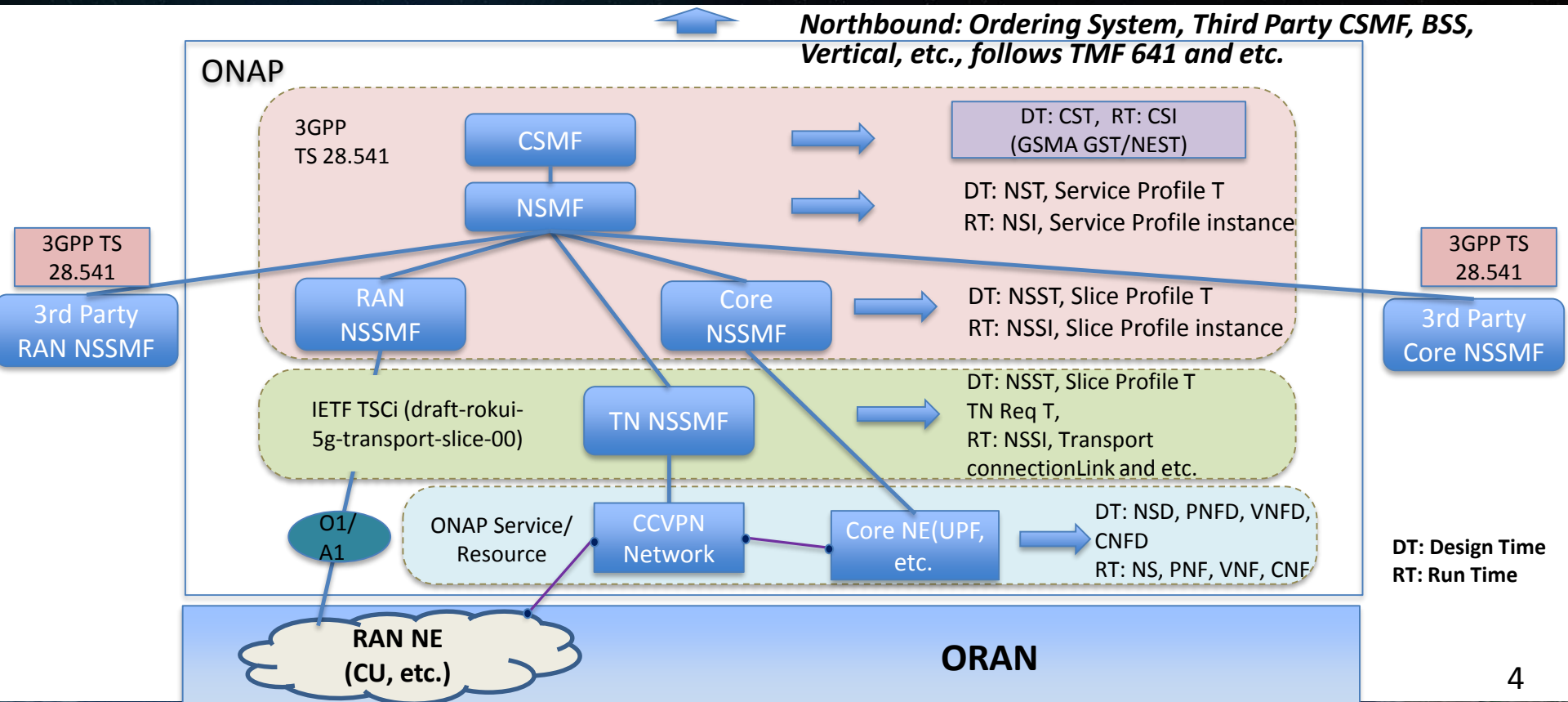

ONAP model conceptions

- CST(CSI): User original requirements from UUI
- Service Profile T(Service Profile Instance) : Network slice requirements for 1 single s-NSSAI, the mapping and translation from CS
- Slice Profile T(Slice Profile Instance) : Network slice subnet requirements for 1 single s-NSSAI, the decomposition from requirements of Service Profile T
- NST: Templates of NSI, E2E slicing capabilities aggregation
- NSST: Templates of NSSI, description of NSSI max capabilities
- TN Req T: Describe the logical resources(links, nodes and etc.) requirements under the TN NSSI

- CST(CSI) refers GSMA GST/NEST
- Service Profile T and NST refer 3GPP TS 28.541 *ServiceProfile*
- Slice Profile T and RAN/Core NSST refer 3GPP TS 28.541 *SliceProfile*
- NSST/TN Req T aligns with IETF

ONAP model conceptions

- Model Working Flows

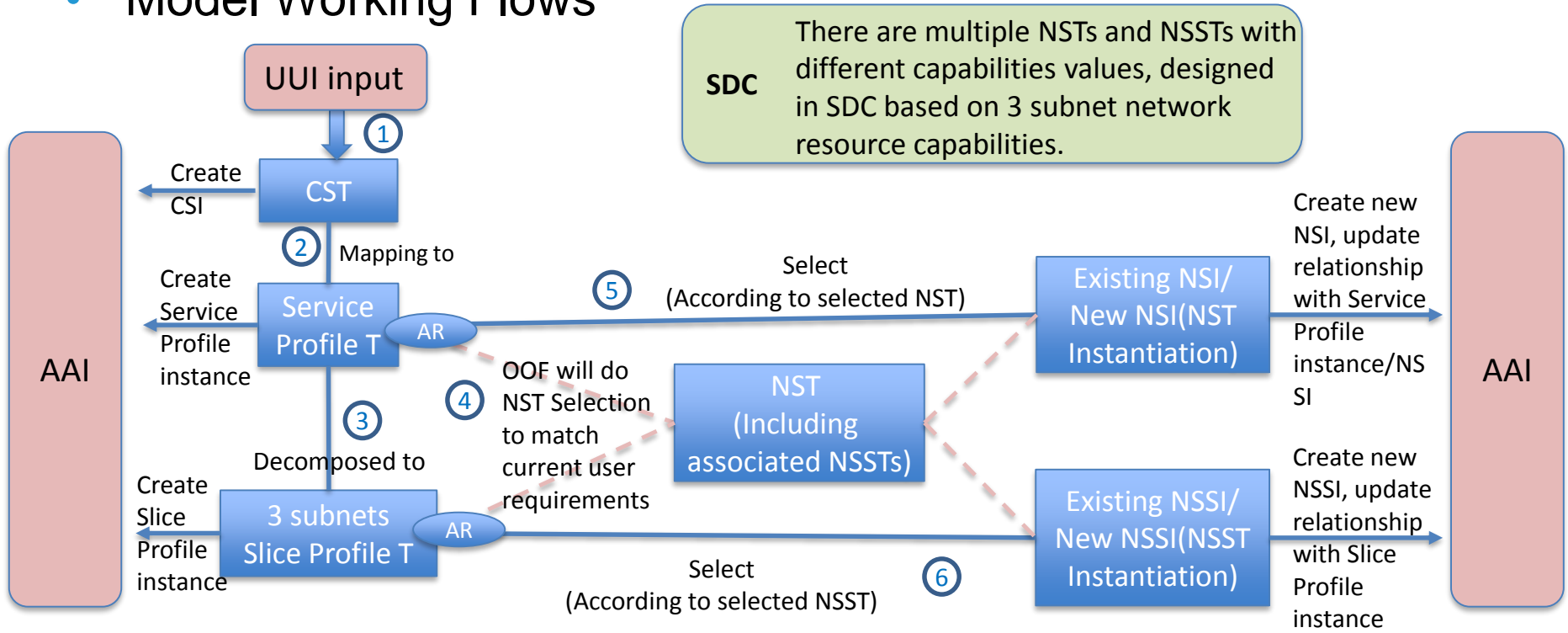

Design time template structure in Guilin

- ONAP Network Slicing Design Time Model Family

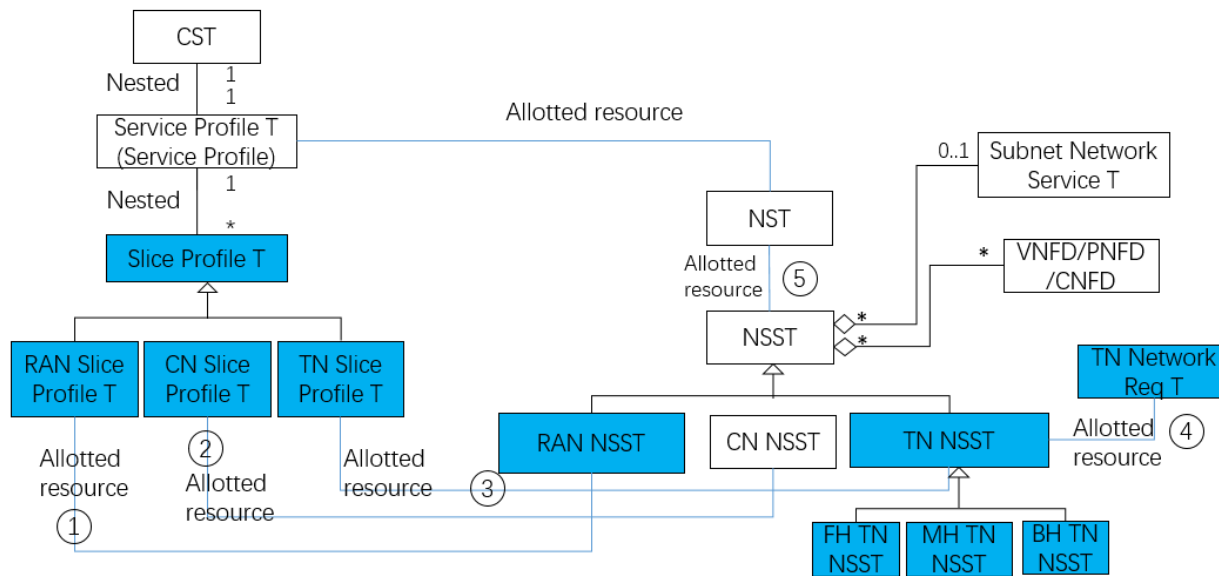

(Blue means new in Guilin)

More introduction about modeling can be found at:

<https://wiki.onap.org/display/DW/Modeling+enhancements>

Design time template structure in Guilin

- RAN Option1 and option 2

Option 1

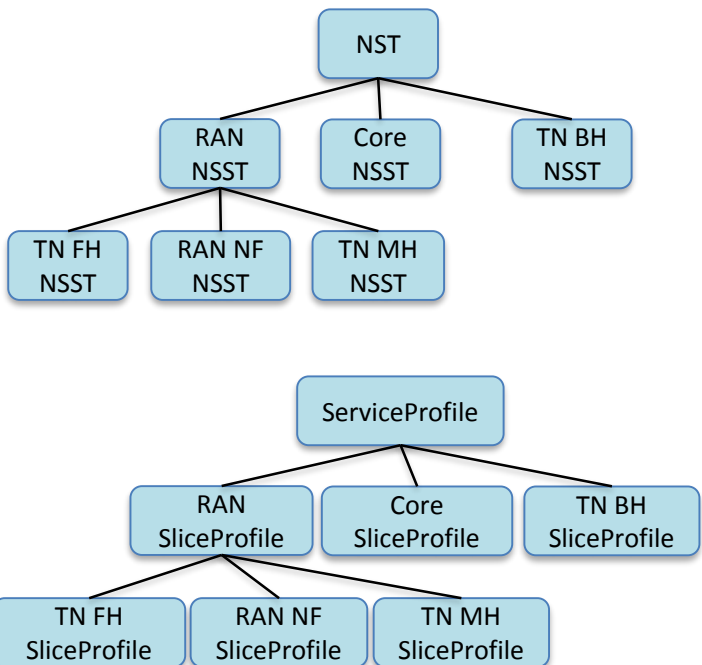

Option 2

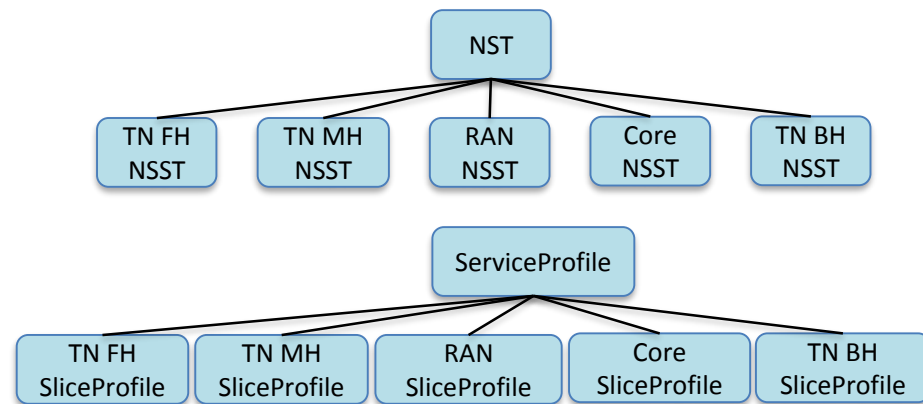

More introduction about Option 1 and 2 can be found at:

<https://wiki.onap.org/display/DW/Assumptions+for+Guilin+release>

Detailed templates design for option 1 and 2 can be found at:

<https://wiki.onap.org/display/DW/Template+Design+for+Option+1>

<https://wiki.onap.org/display/DW/Template+Design+for+Option+2>

AAI Instance Modeling

Wiki: <https://wiki.onap.org/pages/viewpage.action?pageId=93008503>

Snapshot of full instance models

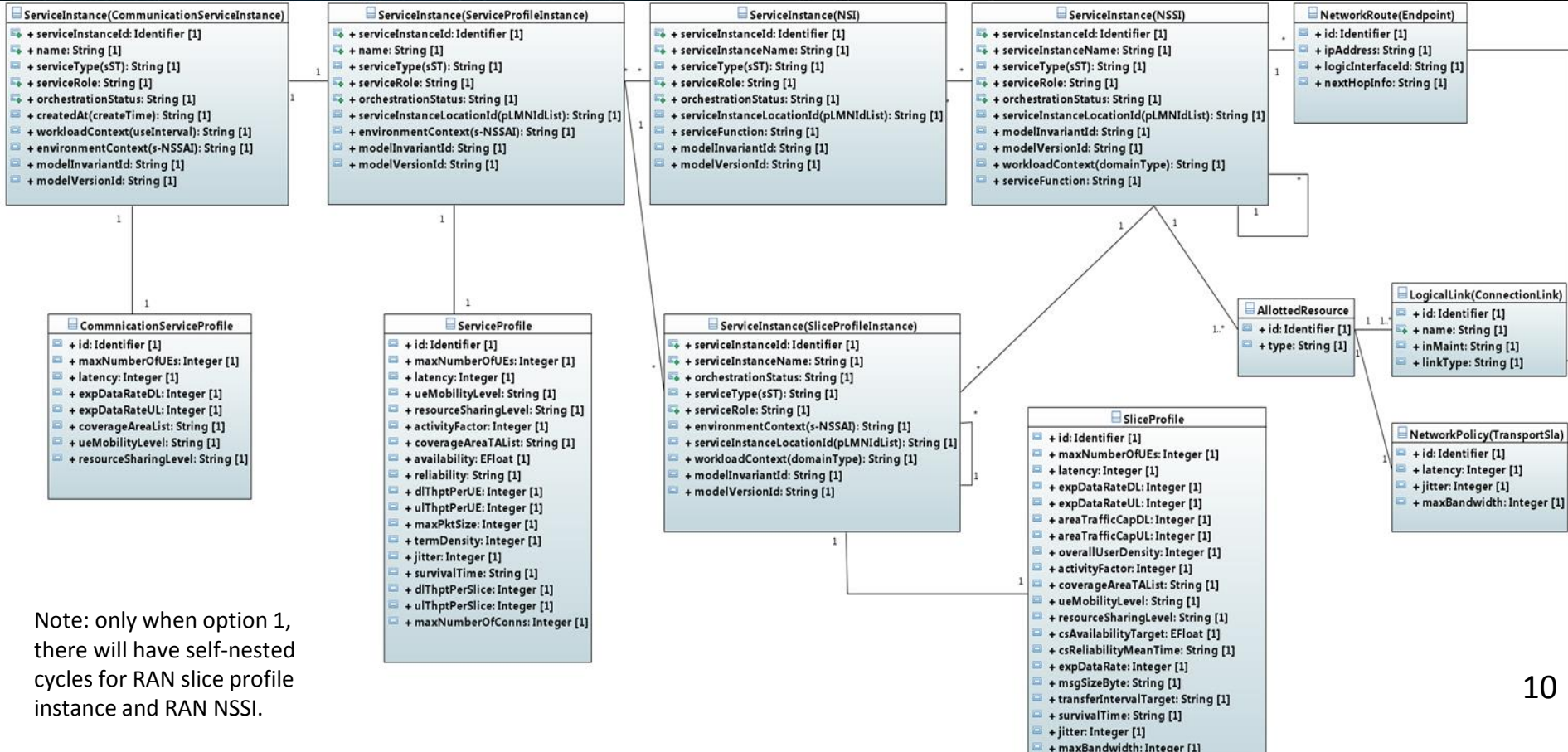

Note: only when option 1, there will have self-nested cycles for RAN slice profile instance and RAN NSSI.

Snapshot of full instance models

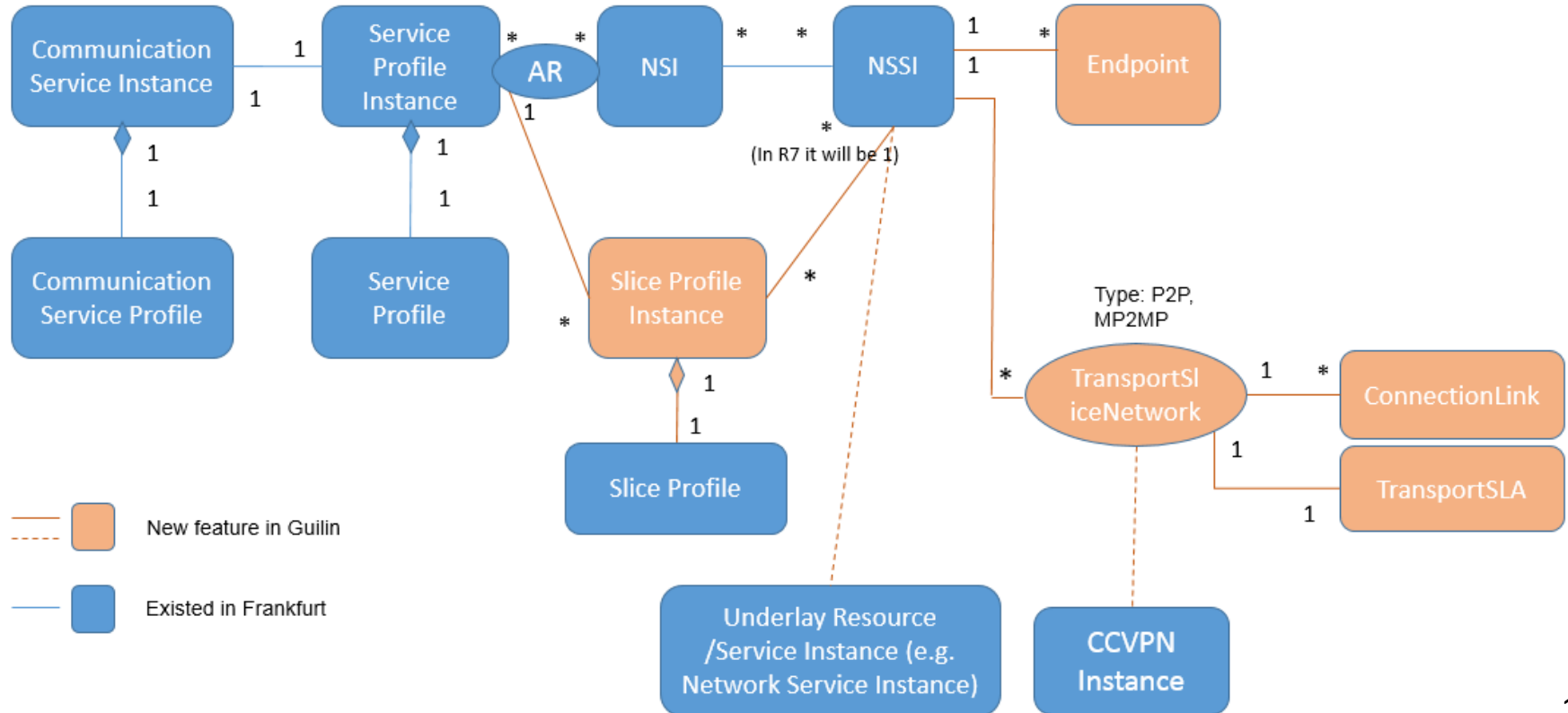

Transport slicing model

- IETF TSCi Information Model

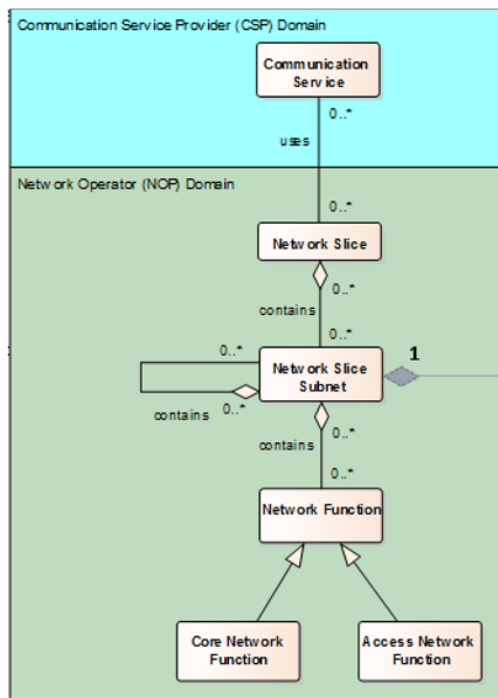

3GPP Network Slice model
conception

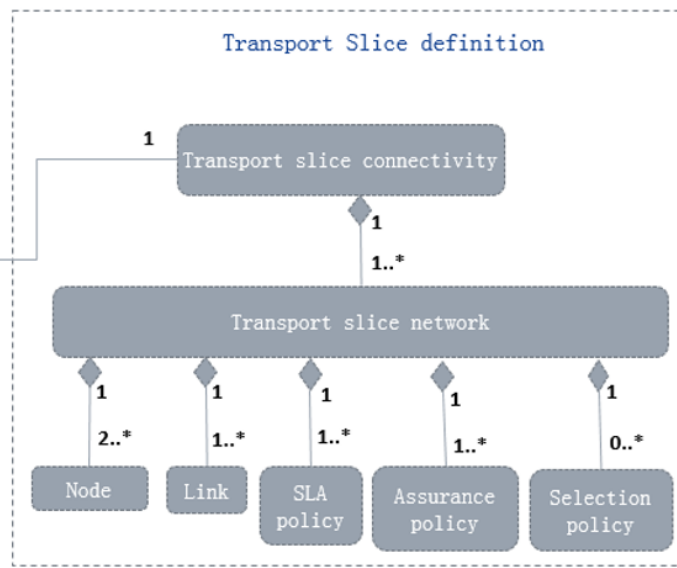

IETF TSCi Network Slice model
conception

- Transport slice connectivity can be seen as TN NSSI
- 1 NSI can have 1 TN NSSI and 1 TN NSSI can support multiple NSIs

Transport slicing model

- IETF TSCi Information Model

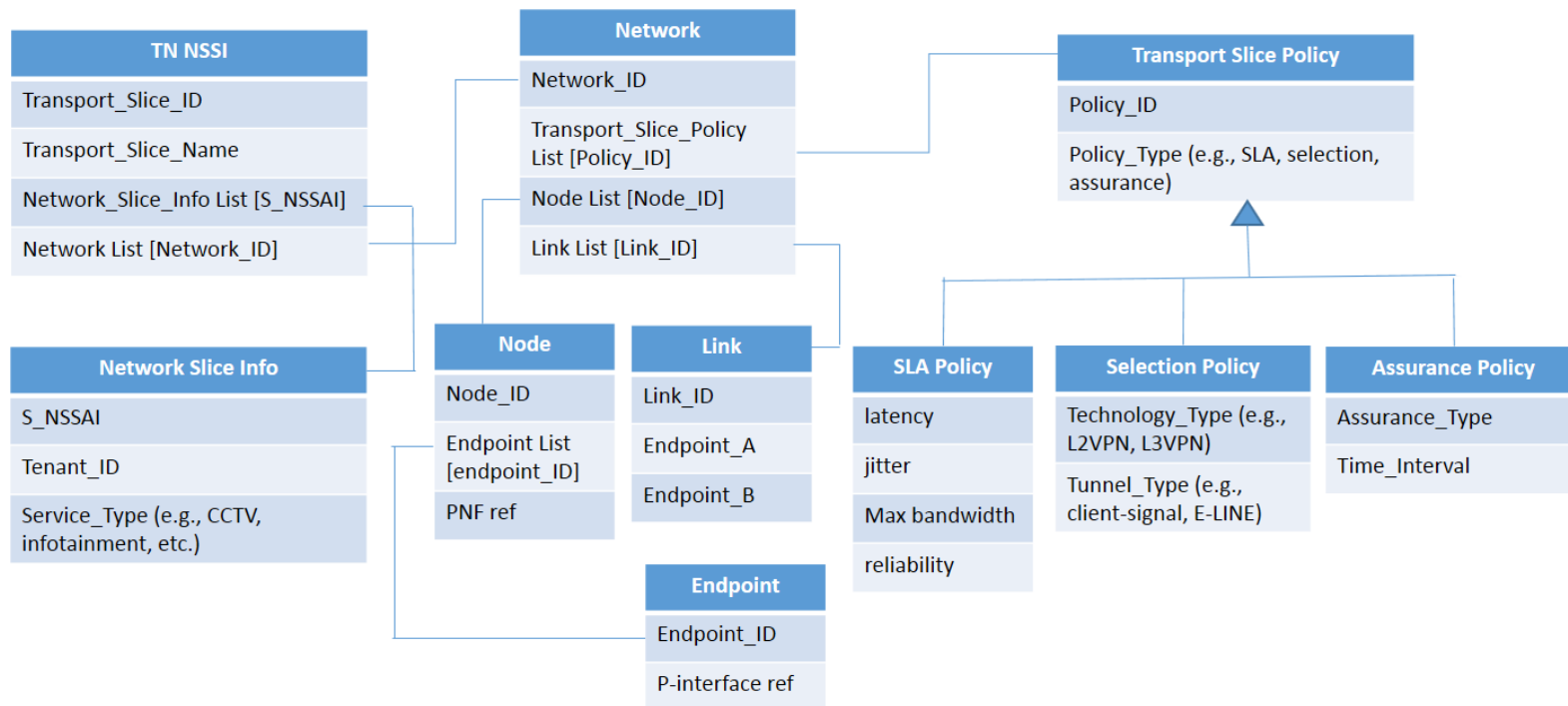

Transport slicing model

- Transport slicing model and ONAP model mapping in Guilin

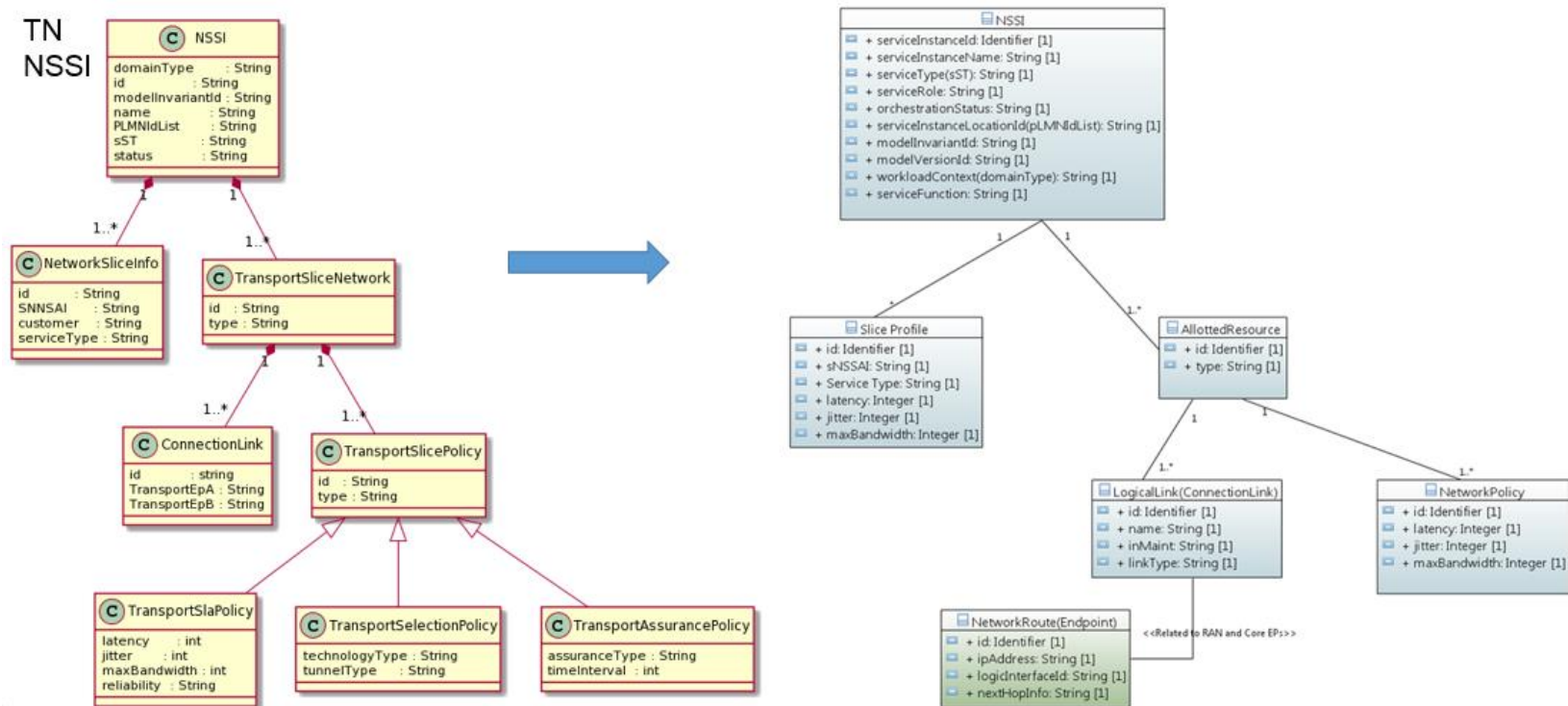

Transport slicing model

- TN NSSI model and CCVPN model correlation

- SO** (TN NSSMF WF) creates and maintains the TN NSSI model.
- In AAI, service-instance is used to model TN NSSI.

`/service-instances/service-instance/{service-instance-id}`

Service-instance model (TN NSSI)

Relationship-list

Connectivity model object (Eth Service for Domain A)

One connectivity per optical domain

Connectivity model object (Eth Service for Domain B)

Relationship-list

Relationship-list

Vpnbinding model object (underlay OTN Tunnel supporting Eth Service)

Vpnbinding model object (underlay OTN Tunnel supporting Eth Service)

AAI Model	Corresponding IETF Model
Service-instance (plus other TN NSSI nodes)	TSCi information model
connectivity	Ethernet Service (EPL/EVPL)
Vpn-binding	OTN Tunnel

- SDNC** creates and maintains what's called TS implementation models. These models are technology specific (e.g., IETF ACTN MPI models in CCVPN)
- In AAI, connectivity is used for ACTN ETH Service model, and vpn-binding for ACTN OTN Tunnel model
- SDNC TS operations (DGs) map TN NSSI model onto ACTN models**

EP: Solution for 3 subnets interworking

- Background: In order to enable 3 subnet connectivity, making end-to-end forwarding and control plane interacting, in slicing services, we need slicing interworking identifier and information to tell how RAN and Core connect with TN.

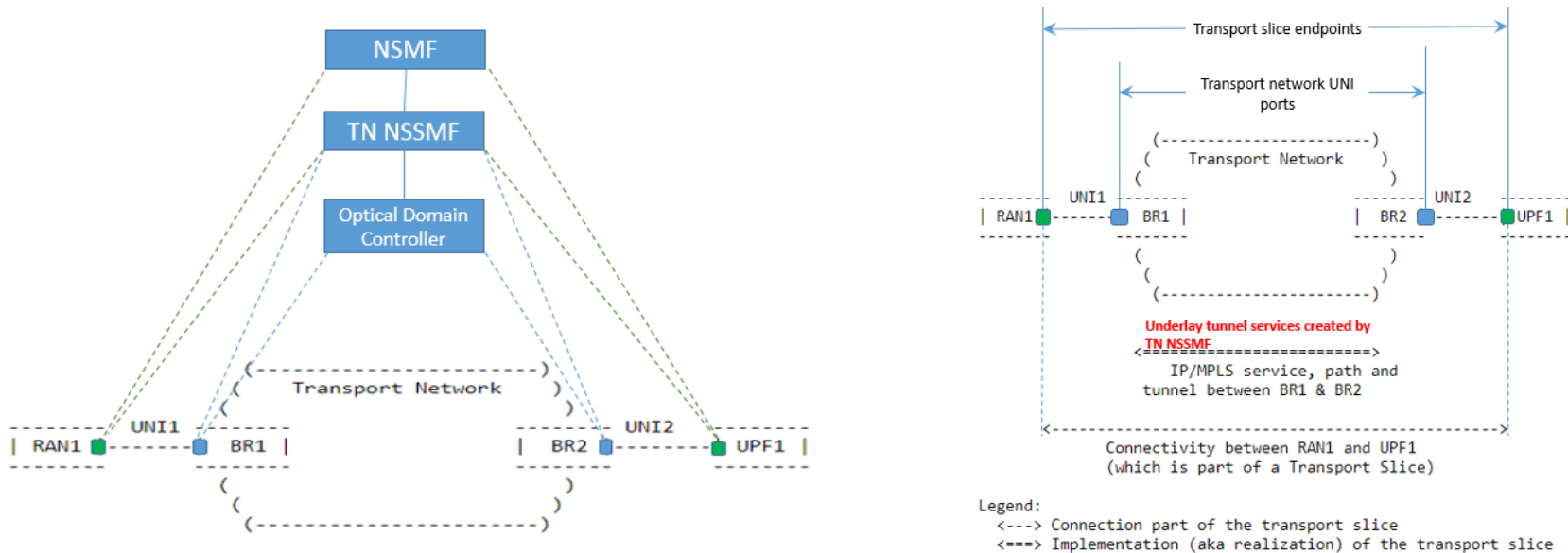

Aim to solve the GREEN points for RAN-TN connectivity and Core-TN connectivity.

Transport connectivity mapping defined by IETF

EP: Solution for 3 subnets interworking

- Reference:
3GPP TS
28.541
EP_Transport

• 6.3.17 EP_Transport

• 6.3.17.1 Definition

This IOC represents the logical transport interface or endpoint which including transport level information, e.g. transport address, reachability information and QoS profiles, etc. ◦

The IOC is inherited from Top IOC. ◦

• 6.3.17.2 Attributes

The EP_Transport IOC includes attributes inherited from Top IOC (defined in TS 28.622[30]) and the following attributes: ◦

Attribute name ◦	Support Qualifier ◦	isReadable ◦	isWritable ◦	isInvariant ◦	isNotifiable ◦
ipAddress ◦	M ◦	T ◦	F ◦	F ◦	T ◦
logicInterfaceId ◦	M ◦	T ◦	T ◦	F ◦	T ◦
nextHopInfo ◦	O ◦	T ◦	F ◦	F ◦	T ◦
qosProfile ◦	O ◦	T ◦	T ◦	F ◦	T ◦
Attribute related to role ◦	◦	◦	◦	◦	◦
epApplicationRef ◦	M ◦	T ◦	T ◦	F ◦	T ◦

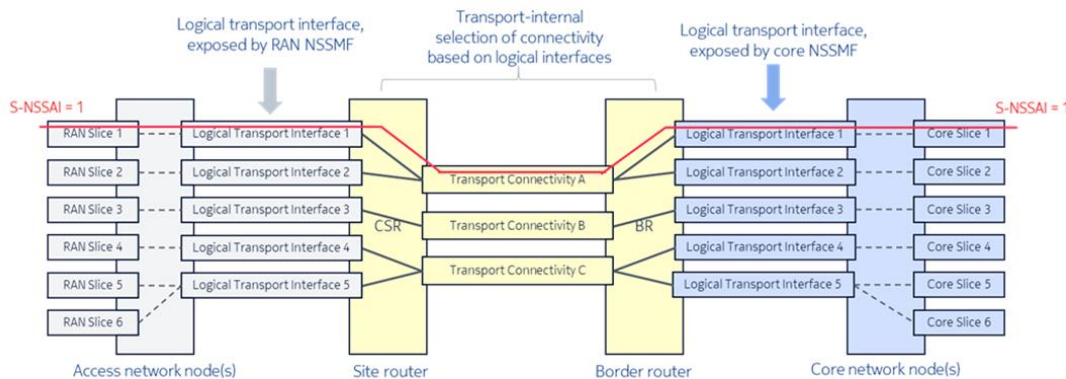
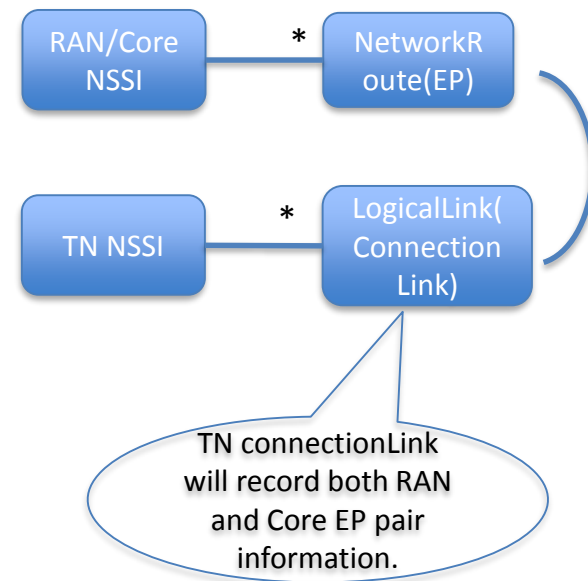

Figure 2 TN NSS example using logical transport interfaces ◦

- ONAP EP related modeling:



H Release enhancement

- **Functional requirements**
 - Support TN NSSI and connectionLink reuse
 - Enhancement for coverage area
- **Modeling requirements**
 - Add *resourceSharingLevel* to TN for supporting TN NSSI reuse, connectionLink can be reused to carry multiple s-NSSAI payloads
 - Add upf and amf information to slice profile for enhancing RAN - Core connectivity
 - Coverage area to support location zone number

Future releases prospect

- How to improve NE level(UPF, CU,DU,...) modeling design to support slicing function
- Support KPI monitoring(To be further studied)
- Service and resource level configuration modeling, consider leveraging CPS, and combine with current models

A background image showing a view of Earth from space, with a bright sun on the left horizon creating a lens flare effect. The text is overlaid on this scene.

OLF NETWORKING

LFN Developer & Testing Forum

Thank You!