

## 5G & PNF Use Cases for R7 Guilin



- ONAP 5G & PNF Use Case Team
- ONAP Subcommittee Meeting Virtual (June 22-25, 2020)

ONAP 5G Use Case Team (Presenters / Ben Cheung, Vimal Begwani)

June 22, 2020 version 2

# R7 Guilin 5G USE CASE SUMMARY

| 5G USE CASE                                      | DESCRIPTION  | Req vs U/C   | 5G Specific |
|--|--|--------------|-------------|
| <b>BULK PM – PM control</b>                      | PM data collection control provides a dynamic and efficient way to configure performance measurement collection on a selected subset of xNFs and complements the existing PM data collection and processing capabilities.      | Requirements | General     |
| <b>OOF - SON PCI (5G)</b>                        | Optimization and SON functions for 5G RAN. Self-optimization, Self-Healing, Self-configuration.  | Requirements | 5G          |
| <b>5G SERVICE MODELING &amp; DEFINITION (5G)</b> | Defining and modeling a 5G Service (in Design Time) and associated Modeling (Platform Info & Data Model).  | Requirements | 5G          |
| <b>CONFIGURATION &amp; PERSISTENCY SERVICE</b>   | Configuration Persistency Service using internal Database for storing Network related data for use in LCM, OSS, Network, Operational applications.   | Requirements | General     |
| <b>xNF LICENSING MANAGEMENT</b>                  | Continue xNF License Management UC analysis for xNF onboarding, PNF introduction/ONAP PnP and VNF instantiation. Bring in new UCs like usage monitoring for the purpose of invoicing.  | Requirements | General     |
| <b>ONAP/3GPP &amp; ORAN Alignment</b>            | <b>Standards Defined Notifications over VES</b> Introducing the capability to receive, validate and process standards defined notifications encapsulated in VES events in ONAP. Also with A1 Adaptor extension.                | Requirements | General     |
| <b>ONAP/ORAN Alignment - A1 adaptor</b>          | A1 adaptor: Enhancing the A1 adaptor/interface capabilities in ONAP to manage A1 Policies, support multiple A1 targets in the RAN and multi-version A1 interface for different A1 targets, introduce secure TLS communication. | Requirements | General     |
| <b>5G NRM (CM)</b>                               | 5G Network Resource Model introducing Configuration Management (CM Updates) using RESTful (HTTPS) Interface (instead of NetConf).  | Requirements | 5G          |
| <b>E2E NETWORK SLICING (5G Use Case)</b>         | Network Slicing defines Slices for 5G RAN systems. Network Slicing is a long-lead (multi-release) development.<br>(will be presented in its own lecture at the Virtual Face to Face)   | E2E Use Case | 5G          |

# R7 Guilin PNF Support U/C SUMMARY

| 5G USE CASE                                | DESCRIPTION   | Req vs U/C   |
|--|---|--------------|
| <b>PNF PRE-ONBOARDING &amp; ONBOARDING</b> | PNF Package delivery, Pre-onboarding and PNF Onboarding via SDC.  | Requirements |
| <b>PNF PLUG AND PLAY</b>                   | PNF PnP handles the PNF discovery and registration by ONAP during installation & commissioning. PRH (PNF Registration Handler) enhancements | E2E Use Case |
| <b>xNF S/W UPGRADE</b>                     | PNF Software upgrade to update the software on a PNF. Use of Ansible/NetConf direct to PNF.   | Requirements |
| <b>PNF - CMPv2</b>                         | Certificate Management Protocol<br>(Will be presented in its own Lecture at the Virtual Face to Face)                                       | Requirements |

# R7 Guilin Use Cases

Dashboard / Developer Wiki / Architecture 1 Jira link 730 view(s)

Edit Save for later Watching Share ...

## Guilin (R7) - Use Cases

Created by Alla Goldner, last modified by Benjamin Cheung just a moment ago

### 5G Use Cases & Requirements in R7 (GuiLin)

The "directory" of 5G Use Case Wiki are located here: [5G Use Cases in R7 Guilin](#)

| USE CASE / REQUIREMENT   | DESCRIPTION   | WIKI   |
|--|---|--|
| <b>OOFS ON (PCI)</b>   | Optimization and SON functions for 5G RAN which provide for self-optimization, self-healing and self-configuration  | <a href="#">R7 OOF SON Use Case</a>  |
| <b>5G SERVICE MODELING &amp; DEFINITION</b>                                      | Defining and modeling a 5G Service (in Design Time) and the associated Modeling (Platform information & data model). This is driven by 3GPP TS28.540 and TS28.541, the 5G NRM.  | <a href="#">R7 5G Service Modeling</a>   |
| <b>ONAP/3GPP &amp; O-RAN Alignment: Standards Defined Notifications over VES</b> | The capability to receive, validate and process standards defined notifications encapsulated in VES events in ONAP.<br>Modeling: VES 7.1  | <a href="#">ONAP/3GPP &amp; O-RAN Alignment-Standards Defined Notifications over VES</a> |
| <b>ONAP/3GPP &amp; O-RAN Alignment: A1 Adaptor Extension</b>                     | A1 Adaptor extension for Standards Harmonization. ONAP acting as Non RT-RIC; ONAP sending policies A1 policy.   |  |
| <b>5G NRM (CM)</b>   | 5G Network Resource Model introducing Configuration Management (CM Updates) using RESTful (HTTPS) Interface (instead of NetConf)  | <a href="#">5G Network Resource Model (NRM) Configuration in R7</a>                      |
| <b>E2E NETWORK SLICING</b>   | 5G Network Slicing defines slices to be used in 5G RAN systems. Network Slicing is a long-lead multi-release development.   | <a href="#">E2E Network Slicing Use Case in R7 Guilin</a>                                |
| <b>BULK PM: PM CONTROL</b>   | PM Control/"PM Control plane" in ONAP has been introduced in Rel 6 to complete Bulk PM use case enabling configuration of PM jobs/subscriptions on xNFs.  |  |
| <b>INTENT BASED NETWORK</b>  | The Intent-based Network (IBN) is applied to the configuration and optimization of network functions based on the Intents. The current version of IBN is applied to the opening and closed-loop operation of network slices in the 5G use case. | <a href="#">Intent-Based Network</a>   |

### PNF Use Cases & Requirements in R7 (GuiLin)

The "directory" for the PNF Use Case Wikis are located here: [PNF Use Cases & Requirements in R7 Guilin](#)

| USE CASE / REQUIREMENT   | DESCRIPTION   | WIKI                                     |
|--------------------------|---|--|
| <b>PNF PLUG AND PLAY</b> | PNF Plug and Play allows for ONAP to support PNF registration and discovery. The DCAE component, PRH (PNF Registration Handler) processes the PNF registration VES event. | <a href="#">R7 PNF Plug and Play PnP</a> |

<https://wiki.onap.org/display/DW/Guilin+%28R7%29+-+Use+Cases>

# Navigating to the Guilin (R7) Use Cases

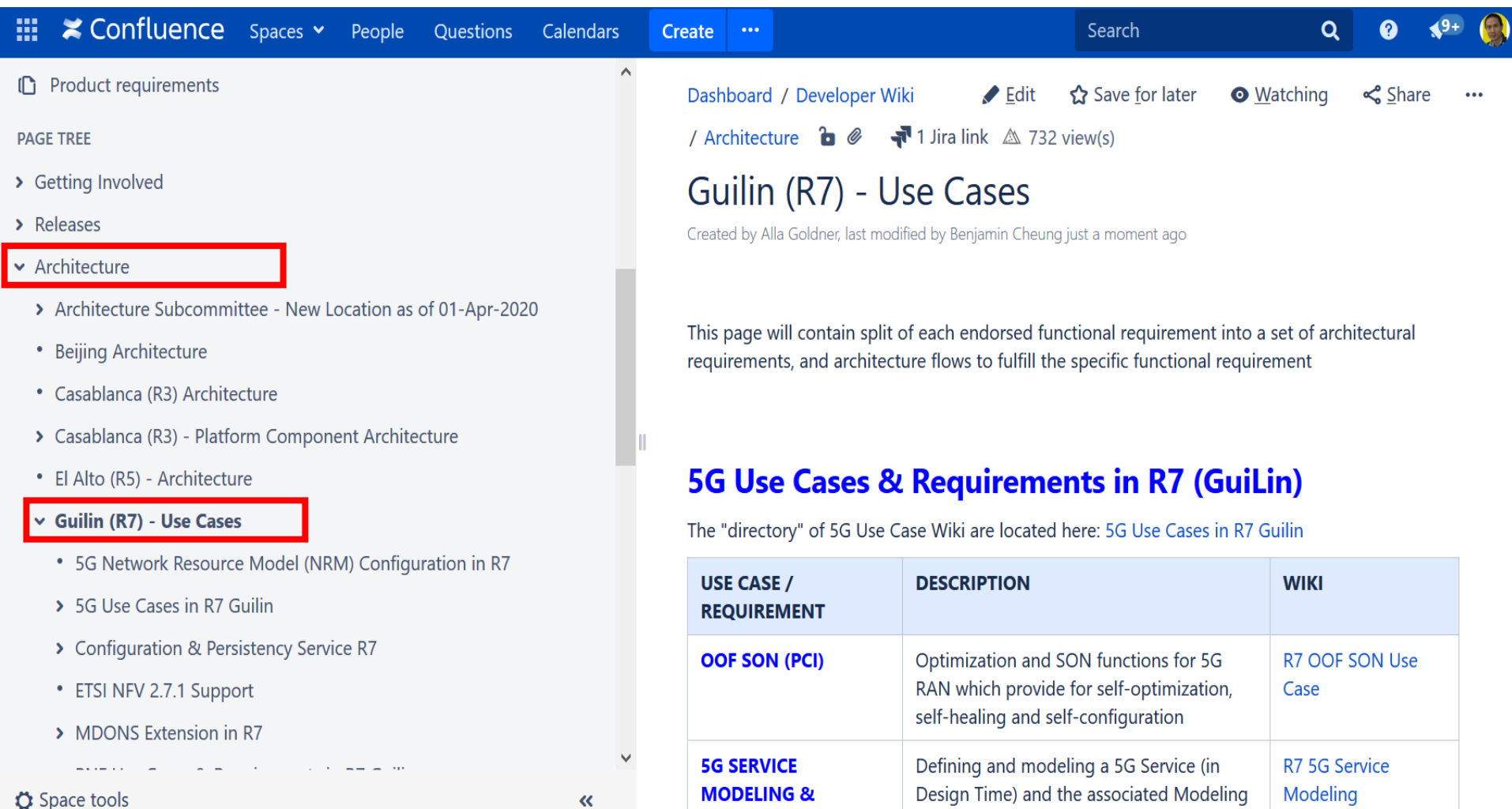

Confluence Spaces People Questions Calendars Create

Search

Product requirements

PAGE TREE

- Getting Involved
- Releases
- Architecture**
  - Architecture Subcommittee - New Location as of 01-Apr-2020
  - Beijing Architecture
  - Casablanca (R3) Architecture
  - Casablanca (R3) - Platform Component Architecture
  - El Alto (R5) - Architecture
  - Guilin (R7) - Use Cases**
    - 5G Network Resource Model (NRM) Configuration in R7
    - 5G Use Cases in R7 Guilin
    - Configuration & Persistency Service R7
    - ETSI NFV 2.7.1 Support
    - MDONS Extension in R7

Space tools

Dashboard / Developer Wiki Edit Save for later Watching Share

/ Architecture 1 Jira link 732 view(s)

## Guilin (R7) - Use Cases

Created by Alla Goldner, last modified by Benjamin Cheung just a moment ago

This page will contain split of each endorsed functional requirement into a set of architectural requirements, and architecture flows to fulfill the specific functional requirement

### 5G Use Cases & Requirements in R7 (GuiLin)

The "directory" of 5G Use Case Wiki are located here: [5G Use Cases in R7 Guilin](#)

| USE CASE / REQUIREMENT           | DESCRIPTION  | WIKI                   |
|----------------------------------|--|------------------------|
| <b>OOF SON (PCI)</b>             | Optimization and SON functions for 5G RAN which provide for self-optimization, self-healing and self-configuration | R7 OOF SON Use Case    |
| <b>5G SERVICE MODELING &amp;</b> | Defining and modeling a 5G Service (in Design Time) and the associated Modeling                                    | R7 5G Service Modeling |

<http://wiki.onap.org/>



# 5G Service Creation Use Case

# 5G Service Model & Creation – Overview

This Use Case will introduce support for 5G Service creation and modeling necessary to create a 5G service, and support an actual 5G PNF (Distributed Unit) in the field in order to have it come on-line and setup first call.

The objective is to be model driven as an objective. To consider how to incorporate Domain (RAN) specific information into the Platform Information Model

ARCHITECTURE REQUIREMENT IDENTITY – ROW 15

[AR-0014-R7-052020](#) [R7 5G PNF SERVICE MODEL INTRODUCTION](#) [Benjamin Cheung](#) [5G](#)

**EXECUTIVE SUMMARY** - This requirement introduces platform information model enhancements to document new ISOMII experimental classes from [3GPP TS28.541](#), the 5G Network Resource Model (NRM).

**BUSINESS IMPACT** - The requirement, is a critical because it will serve to lay the ground-work for actually "turning on" a real 5G DU (PNF) that might be installed by a Vendor.

**BUSINESS MARKETS** - This project applies to any domain (wireless, transport, optical, and wireline) that ONAP may manage.

**FUNDING/FINANCIAL IMPACTS** - Without the groundwork laid down for information model management of a 5G Service, operators will not be able to "turn on" a real live 5G network using "live" PNF resources. No Network. No Business. High OPEX impact.

**ORGANIZATION MGMT, SALES STRATEGIES** - There is no additional organizational management or sales strategies for this use case outside of a service providers "normal" ONAP deployment and its attendant organizational resources from a service provider.

# 5G SERVICE CREATION & MODELING in R7 Guilin

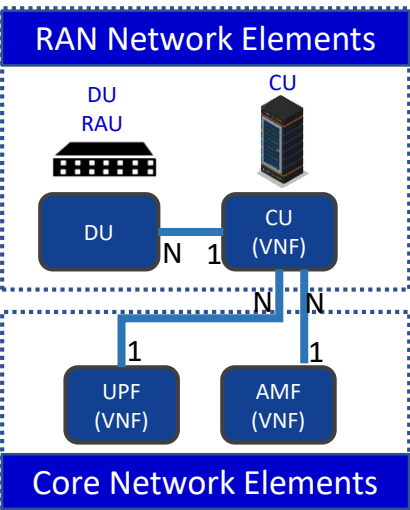
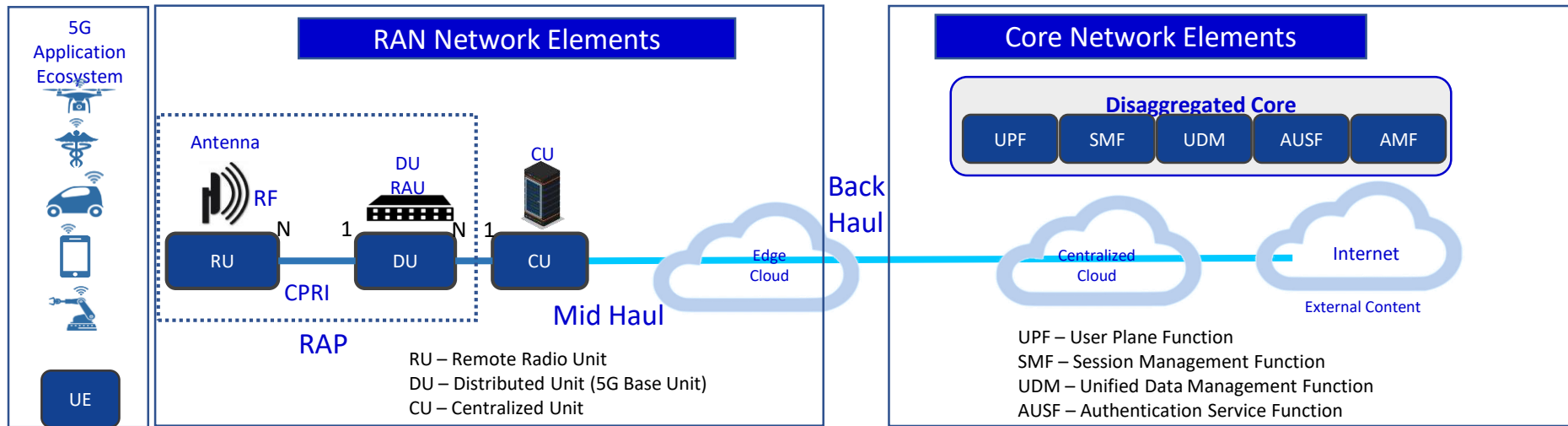

**5G SERVICE**

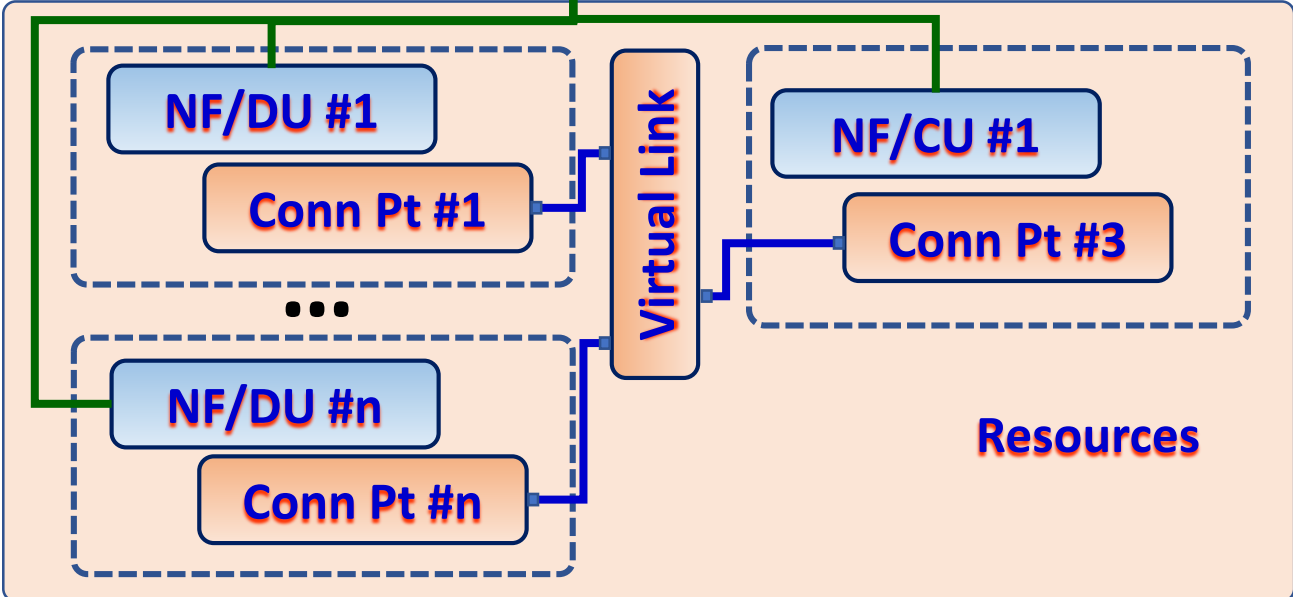



# 5G Service Model & Creation – Overview

3GPP TS 28.541 V15.4.0 (2019-09)

Technical Specification

3rd Generation Partnership Project;  
Technical Specification Group Services and System Aspects;  
Management and orchestration;  
5G Network Resource Model (NRM);  
Stage 2 and stage 3  
(Release 15)

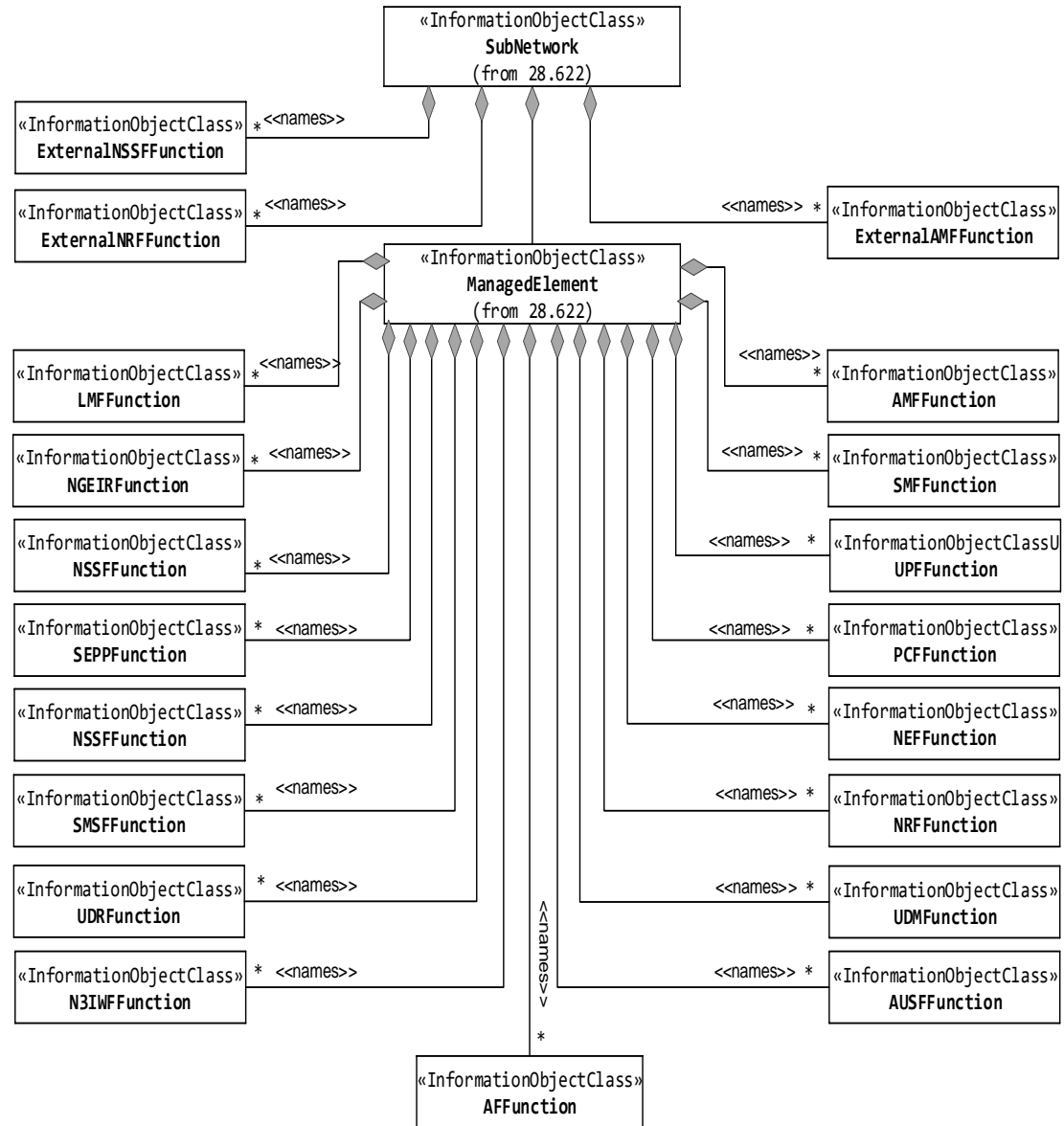

# R7 Model Driven C&PS PoC > Model Driven Configuration

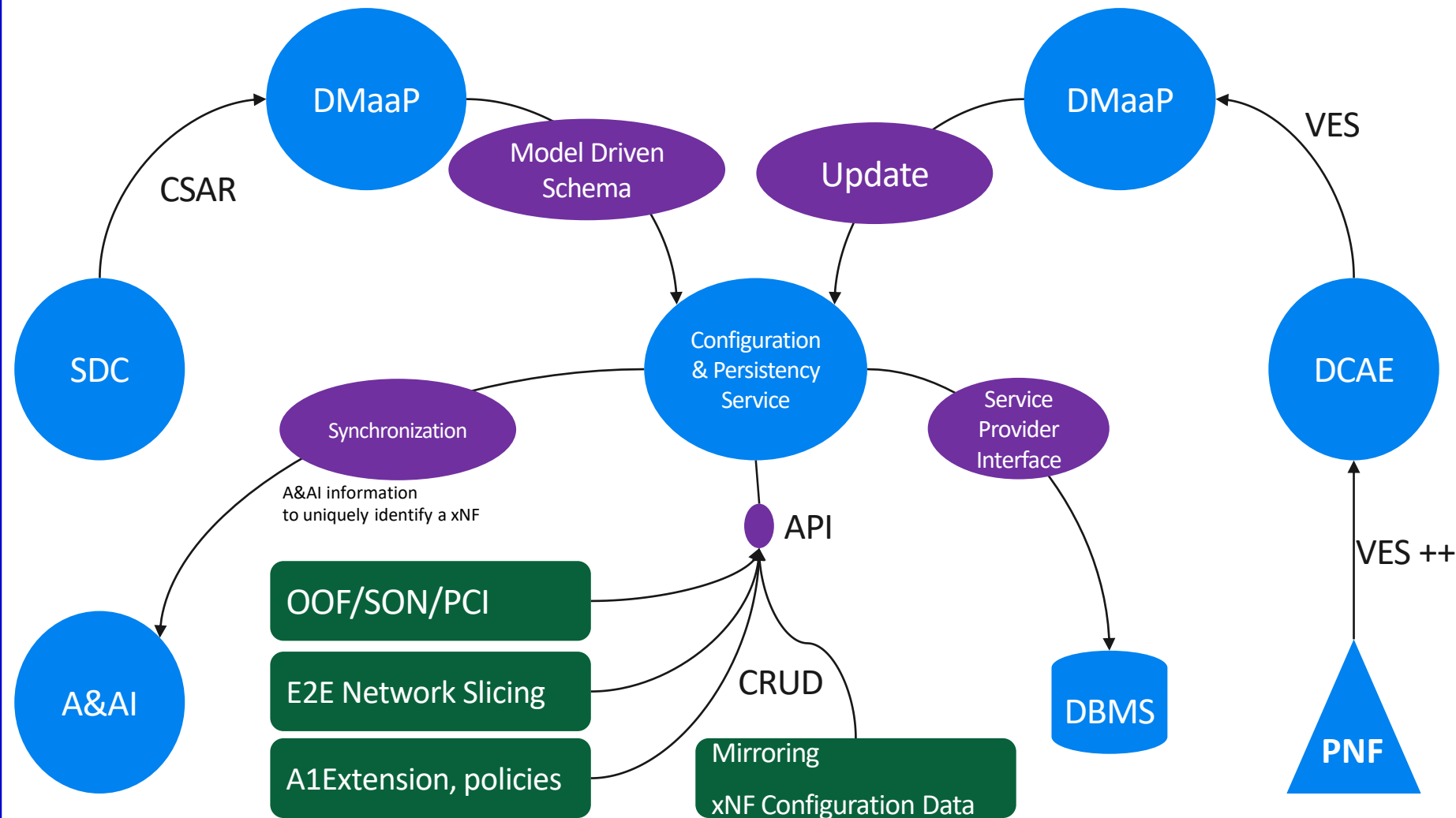
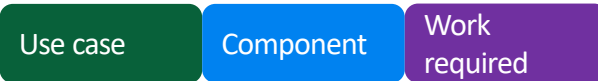

# 5G SERVICE CREATION & MODELING in R7 Guilin

Wiki

<https://wiki.onap.org/display/DW/R7+5G+Service+Modeling>

R7 Guilin NEW COMPONENT CAPABILITIES

| R7 NEW COMPONENT CAPABILITIES | IMPACT DESCRIPTION  |
|-------------------------------|---|
| Modelling S/C                 | <p>Evolution of Platform Info &amp; Data model in support of 5G Service Service from 3GPP TS28.540 and TS28.541 5G NRM standards for modeling a service (might need alignment). Platform data/information model.</p> <p>To introduce one object from the 3GPP TS28.541. even if it is ISOMII Experimental</p> <ol style="list-style-type: none"><li>(1) The objective is to be model driven as an objective.</li><li>(2) To consider how to incorporate Domain (RAN) specific information into the Platform Information Model</li></ol> |
|                               | <p>Modeling S/C suggests:<br/>maybe model the <b>"core" service model</b>; links-connectivity where we can hang tech-specific details off of. Perhaps borrow the ONF model (et al); Plug tech this into a common "core" model</p>   |

# 5G SERVICE CREATION & MODELING in R7 Guilin

|                         |                   |                       |
|-------------------------|-------------------|-----------------------|
| <b>ExternalNRCellCU</b> | NR NRM            | nRPCI                 |
| NetworkSlice            | Network Slice NRM | operationalState      |
| NetworkSlice            | Network Slice NRM | administrativeState   |
| NetworkSlice            | Network Slice NRM | serviceProfileList    |
| NetworkSlice            | Network Slice NRM | networkSliceSubnetRef |
| NetworkSliceSubnet      | Network Slice NRM | operationalState      |
| NetworkSliceSubnet      | Network Slice NRM | administrativeState   |
| NetworkSliceSubnet      | Network Slice NRM | nsInfo                |
| NetworkSliceSubnet      | Network Slice NRM | sliceProfileList      |
| NetworkSliceSubnet      | Network Slice NRM | managedFunctionRef    |
| NetworkSliceSubnet      | Network Slice NRM | networkSliceSubnetRef |
| ServiceProfile          | Network Slice NRM | serviceProfileId      |
| ServiceProfile          | Network Slice NRM | sNSSAList             |
| ServiceProfile          | Network Slice NRM | pLMNIdList            |
| ServiceProfile          | Network Slice NRM | perfReq               |
| ServiceProfile          | Network Slice NRM | maxNumberOfUEs        |
| ServiceProfile          | Network Slice NRM | coverageAreaTAList    |
| ServiceProfile          | Network Slice NRM | latency               |
| ServiceProfile          | Network Slice NRM | uEMobilityLevel       |
| ServiceProfile          | Network Slice NRM | resourceSharingLevel  |
| ServiceProfile          | Network Slice NRM | sST                   |
| ServiceProfile          | Network Slice NRM | availability          |
| SliceProfile            | Network Slice NRM | sliceProfileId        |
| SliceProfile            | Network Slice NRM | sNSSAList             |
| SliceProfile            | Network Slice NRM | pLMNIdList            |
| SliceProfile            | Network Slice NRM | perfReq               |
| SliceProfile            | Network Slice NRM | maxNumberOfUEs        |
| SliceProfile            | Network Slice NRM | coverageAreaTAList    |
| SliceProfile            | Network Slice NRM | latency               |
| SliceProfile            | Network Slice NRM | uEMobilityLevel       |
| SliceProfile            | Network Slice NRM | resourceSharingLevel  |

# INTERFACES & APIs

R7 Guilin Interfaces Impacts

| R7 Interfaces | IMPACT                      |
|---------------|-----------------------------|
| (None)        | (None – Modeling work only) |
|               |                             |

R7 Guilin APIs Impacts

| R7 API | IMPACT                      |
|--------|-----------------------------|
| (None) | (None – Modeling work only) |
|        |                             |



# Bulk PM – PM Control Extensions

# Bulk PM – PM Control

- PM Control/“PM Control plane” in ONAP has been introduced in Rel 6 to complete Bulk PM use case enabling configuration of PM jobs/subscriptions on xNFs.
- PM consumers can conveniently define PM subscriptions on (sub)network-level, thereby configuring PM on a set (small or large) of xNF instances in a single subscription. Different consumers to manage their own subscriptions, independently of each other

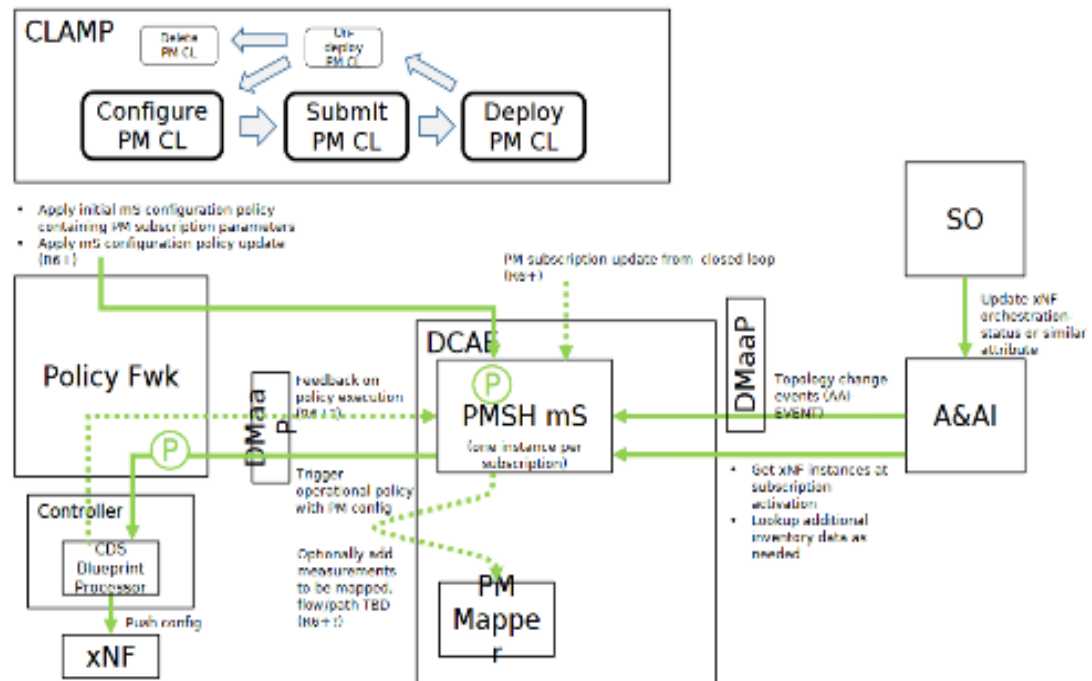
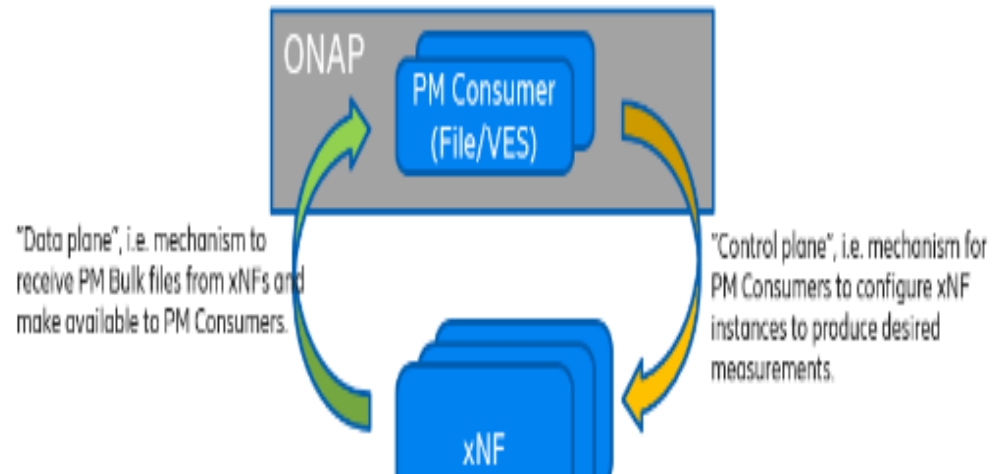

# Bulk PM – PM Control for R7 Guilin

PM data collection control provides 5G network operators with a dynamic and more efficient way to configure performance measurement collection on a selected subset of PNFs/VNFs in the network and complements the existing PM data collection and processing capabilities in ONAP/DCAE. An initial version has been delivered in Rel 6 (5G / Bulk PM / PM Control - [REQ-129](#)). Planned enhancements for Rel 7 intend to further increase the capability and the dynamicity of this feature.

Key Contacts: Michela Bevilacqua (Ericsson), Mark Scott (Ericsson)

<https://wiki.onap.org/pages/viewpage.action?pageId=84644982>

| R7 CANDIDATE ENHANCEMENTS | DESCRIPTION  |
|---------------------------|--|
| DCAE                      | <ul style="list-style-type: none"><li>Improve usability of PMSH instantiation with CLAMP integration and enhanced Policy support.</li><li>Support for additional A&amp;AI parameters to allow more flexible filtering.</li><li>Support dynamic modification of subscriptions.</li><li>Error handling improvements and logging enhancement to comply with DCAE guidelines.</li><li>Enable PMSH to support N subscriptions</li></ul> |





# OOF SON PCI Use Case

# 5G Self-Organizing Network using OOF in R7 Guilin

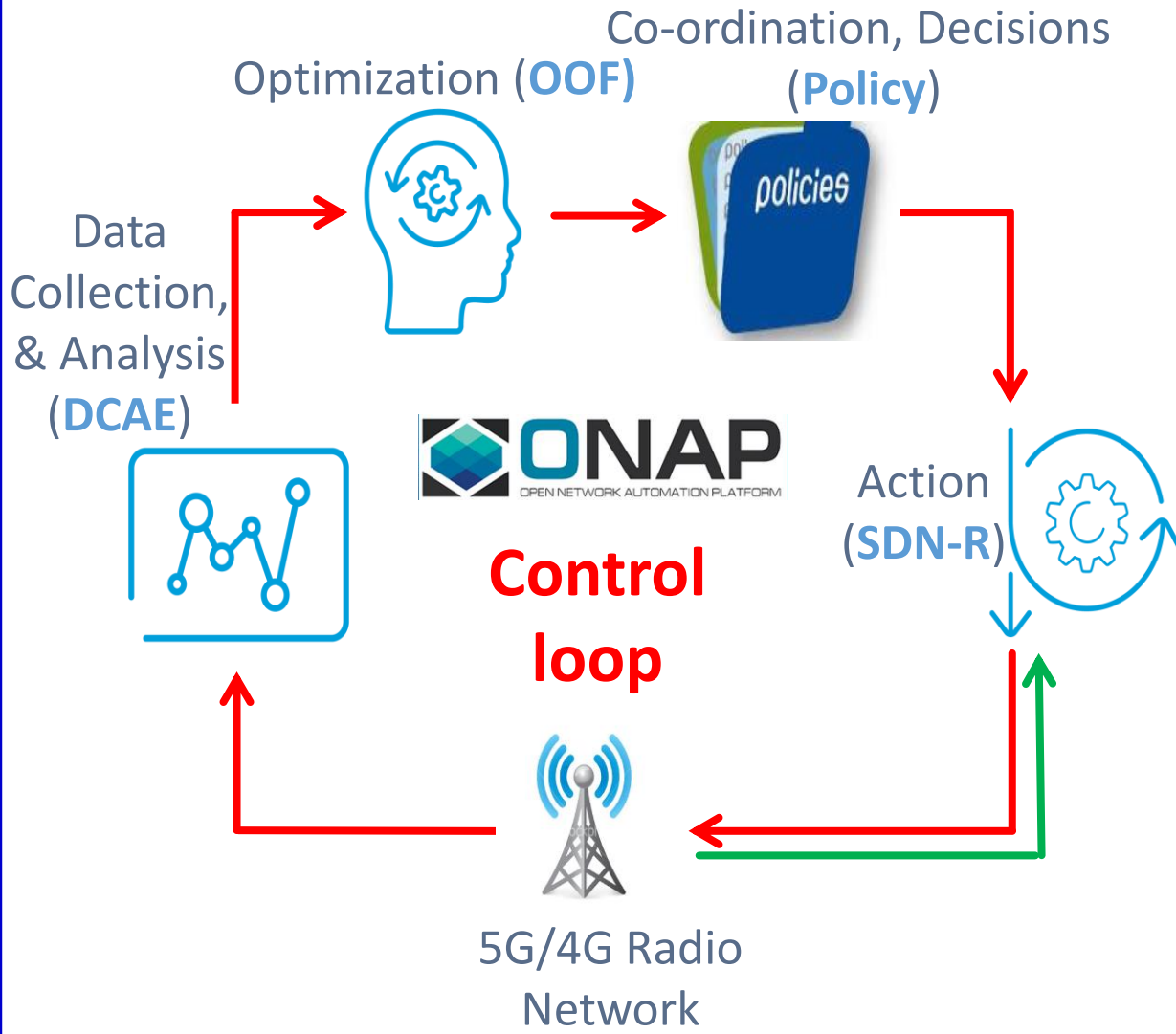

- SON ⇔ Control Loop (CL)
- ONAP: Open-source platform, with basic open-source code
- Companies can use framework to add proprietary SON solutions
- OOF-PCI Casablanca –
  - First ONAP SON PCI use case
  - PoC Demo in Dec 2018
- OOF-PCI Dublin
  - Added SON function: ANR
  - More SON data flows: FM, PM
  - More ONAP code integration

# 5G Self-Organizing Network using OOF in R7 Guilin

- Physical cell ID (PCI) is a locally unique integer ID in 4G/5G
  - Used for handoff and physical layer design
  - PCI ranges: (LTE: 0-503, 5G: 0-1007)
- PCI optimization: Assign PCI values to avoid **PCI collision** and minimize **PCI confusion**
- Automated Neighbor Relations (ANR) builds & maintains neighbor relation tables in eNodeB and gNodeB
  - Distributed ANR in eNodeB, gNodeB
  - Centralized ANR optimizes neighbor tables based on global information
- PCI needs to be re-optimized if neighbor relationship changes, (e.g. during distributed ANR function in RAN)
- Centralized ONAP ANR optimization is best done jointly with PCI - blacklisting neighbors from HO based on HO metrics over a period of time

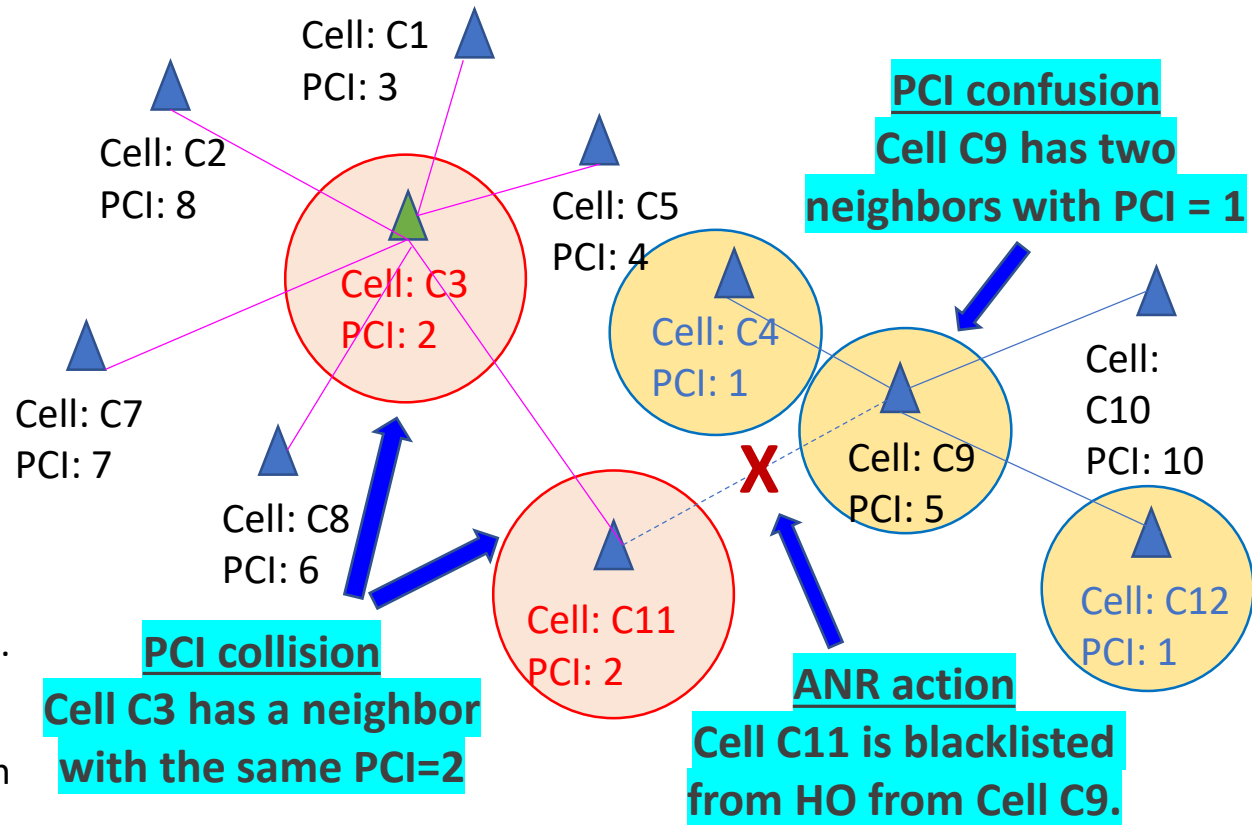

Graph Coloring Problem

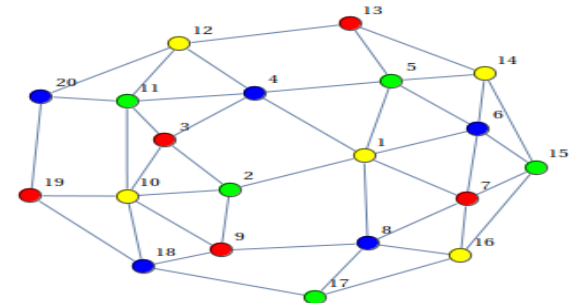

# 5G Self-Organizing Network using OOF in R7 Guilin

## Key areas for requirements & functions for SON/OOF in R7

|   |  |
|---|--|
| <b>O-RAN alignment (VES, O1 interface)</b>                            | Receive Configuration Management (CM) notifications over VES (instead of netconf)  |
| <b>RAN Database (Runtime Config DB), including any new RAN models</b> | 1. Data models/DB schema and APIs to be generated from yang models; 2. Details of cells to be stored with PNF reference in AAI<br>2. Modeling of RAN functions and objects |
| <b>Control Loop Coordination (CLC) extensions</b>                     | Collaborate on CLC extensions (queueing, priority, ...)  |
| <b>Integration of SON and PNF onboarding functions</b>                | 1. New cell(s) addition – extension to PNF onboarding & registration scenario, addition of new cell later to a PNF<br>2. Initial assignment of PCI to a cell               |
| <b>New SON function to evolve ONAP platform</b>                       | 1. SON based on data/KPI analysis ; 2. CLC interaction and 3. Machine Learning (ML) aspects in DCAE  |
| <b>SON Lifecycle</b>  | Role of SO, SDC, CLAMP (for SON service/feature deployment)  |
| <b>Real gNB interaction</b>   | Interaction with real gNB in lab   |

<https://wiki.onap.org/display/DW/R7+OOF+SON+Use+Case>

| R7 ENHANCEMENTS                           | IMPACT   |
|---|--|
| OOF                                       | <ul style="list-style-type: none"> <li>Optimization enhancements</li> </ul>  |
| SDN-R                                     | <ul style="list-style-type: none"> <li>Enhance Yang model to align with 3GPP and O-RAN</li> <li>Receive Configuration Management (CM) notifications over VES</li> <li>Align with CPS interface</li> </ul>  |
| DCAE                                      | <ul style="list-style-type: none"> <li>SON based on data/KPI analysis</li> <li>Machine Learning (ML) aspects in DCAE</li> <li>CLC interaction</li> </ul>   |
| POLICY                                    | <ul style="list-style-type: none"> <li>Collaborate on CLC extensions (queueing, priority, ...)</li> <li>Enhancements to Frankfurt implementation related to SON Control loops</li> </ul>   |
| SO  | <ul style="list-style-type: none"> <li>PNF onboarding &amp; registration scenario, addition of new cell later to a PNF</li> <li>Trigger OOF for assignment of PCI to a new cell</li> </ul>   |
| CPS (Configuration & Persistency Service) | <ul style="list-style-type: none"> <li>Data models/DB schema and APIs to be generated from yang models</li> <li>Details of cells to be stored in CPS, along with reference to PNF in AAI</li> <li>Modeling of RAN functions and objects</li> </ul> |
| RAN-Simulators                            | <ul style="list-style-type: none"> <li>CM-Notify sending over VES, reporting of necessary PM/FM data</li> </ul>  |

U/C DESCRIPTION

Wiki

R7 Guilin CANDIDATE ENHANCEMENTS

# 5G Self-Organizing Network using OOF in R7 Guilin

R7 REQUIREMENTS

| Category         | Requirement  | Content  |
|------------------|--|--|
| Interoperability | O-RAN alignment (VES, O1 interface)                            | Receive Configuration Management (CM) notifications over VES (instead of netconf)  |
| Functional       | RAN Database (Runtime Config DB), including any new RAN models | <ol style="list-style-type: none"> <li>1. Data models/DB schema &amp; APIs to be generated from yang models</li> <li>2. Details of cells to be stored with PNF reference in AAI</li> <li>3. Modeling of RAN functions and objects</li> </ol> |
| Platform         | Control Loop Coordination (CLC) extensions                     | Collaborate on CLC extensions (queueing, priority, ...)  |
| Functional       | SON function to evolve ONAP platform                           | <ol style="list-style-type: none"> <li>1. SON based on data/KPI analysis</li> <li>2. CLC interaction</li> <li>3. Machine Learning (ML) aspects in DCAE</li> </ol>  |
| Functional       | SON Lifecycle  | Role of SO, SDC, CLAMP (for SON service/feature deployment) (stretch goal)   |
| Interoperability | Real gNB interaction   | Interaction with real gNB in lab (stretch goal)  |

# 5G Self-Organizing Network using OOF in R7 Guilin

R7 REQUIREMENTS

| COMPONENT                                 | IMPACT(S)  |
|---|--|
| OOF                                       | <ul style="list-style-type: none"> <li>• Optimization enhancements</li> <li>• Impacts for ML-based SON (sub-component, interface from OSDF)</li> </ul>   |
| SDN-C (SDN-R)                             | <ul style="list-style-type: none"> <li>• Enhance Yang model to align with 3GPP and O-RAN</li> <li>• Receive Configuration Management (CM) notifications over VES</li> <li>• Align with CPS interface</li> </ul>  |
| DCAE                                      | <ul style="list-style-type: none"> <li>• CLC interactions</li> <li>• Impacts due to enhancements in Policy related to Control Loops</li> <li>• Potential enhancements in case a new SON use case is considered for ML-based SON.</li> </ul>                  |
| POLICY                                    | <ul style="list-style-type: none"> <li>• Collaborate on CLC extensions (queueing, priority, ...)</li> <li>• Enhancements to Frankfurt implementation related to Control loops</li> </ul>   |
| CPS (Configuration & Persistency Service) | <ul style="list-style-type: none"> <li>• Data models/DB schema and APIs to aligned to new yang models</li> <li>• Details of cells to be stored in CPS, along with reference to PNF in AAI</li> <li>• <i>Modeling of RAN functions and objects</i></li> </ul> |
| RAN-Sim (Simulators)                      | <ul style="list-style-type: none"> <li>• Enhancements related to CM-Notify sending over VES, reporting of necessary PM/FM data for a new SON function</li> </ul>   |

# 5G Self-Organizing Network using OOF in R7 Guilin

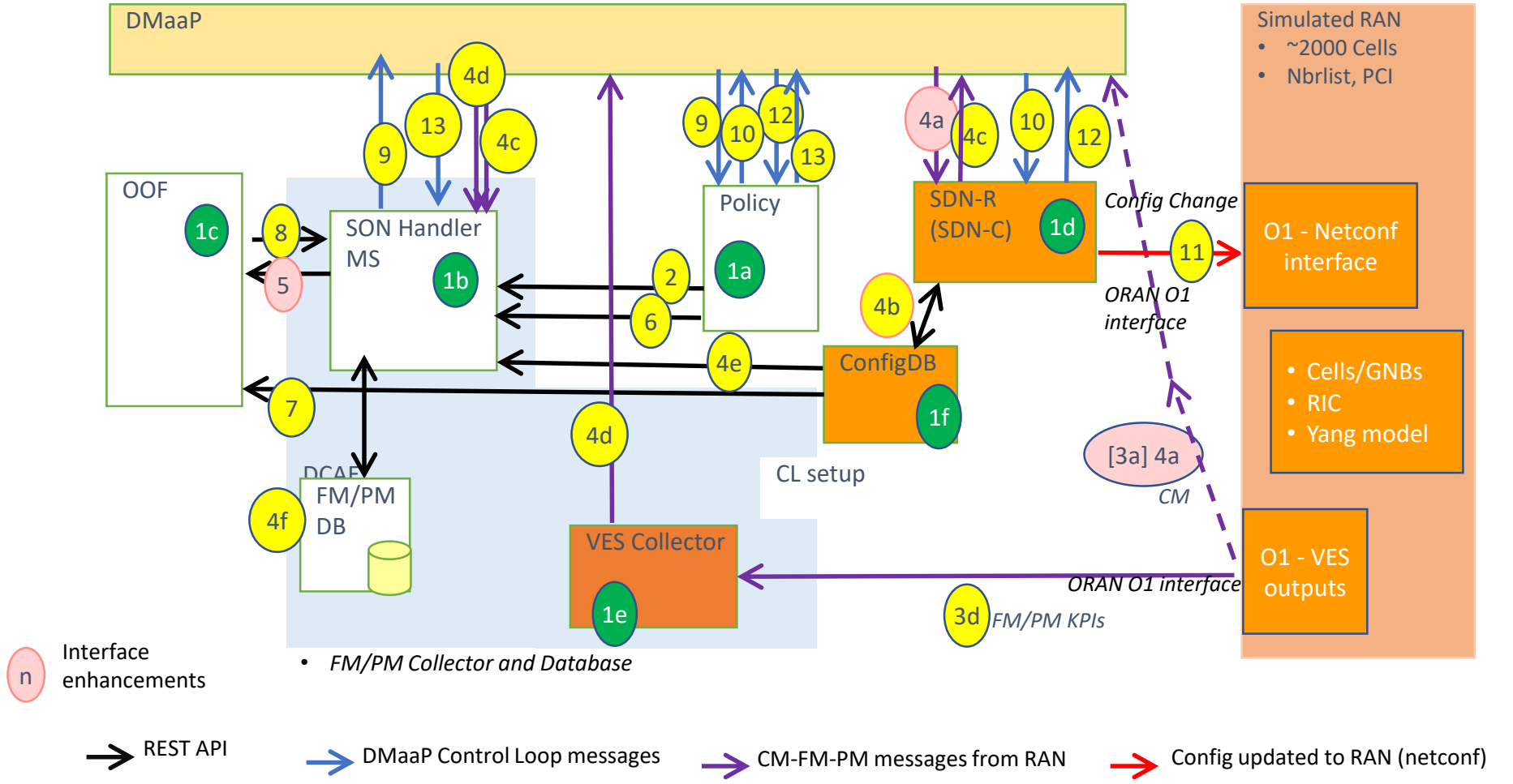



# LICENSING MANAGEMENT



# LICENSING MANAGEMENT in R7 Guilin

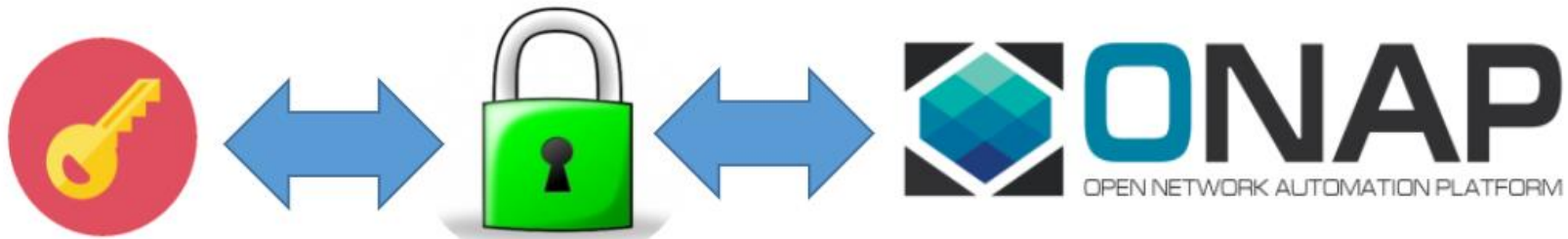

**Executive Summary** - Continue use case analysis for xNF License Management and derive any requirements to ONAP. The aim is for ONAP to support various types (simple, complex, vendor specific) commercial licensing models and use cases. These will be reflected as multiple, optional solutions for ONAP. The use cases we started with include xNF onboarding, PNF introduction/ONAP PnP, VNF instantiation. Further use cases to be analyzed, e.g. usage monitoring for the purpose of invoicing. Based on agreed use cases review relevant ONAP xNF requirements. Possible SW contributions, e.g. in SDC, as well as enhancement of ONAP architecture sequence diagrams.

**Business Impact** - xNF License Management is a critical business function. Agreed use cases should allow ONAP to flexibly support commercial licensing models.

**Business Markets** – The requirement applies to any domain (wireless, transport, optical, wireline) that ONAP will manage. It is not a market specific function.

**Funding/Financial Impacts** - The use case is fundamental for supporting efficiently business agreements between the operator and the vendor.

# LICENSING MANAGEMENT in Design Time

## Create a Licensing Model

- CREATE NEW VLM with a license Name, description
  - ADD ENTITLEMENT POOL : name
  - ADD LICENSE KEY GROUP (optional): name and universal type
  - ADD FEATURE GROUP: name, part number, manufacturer reference number, link a entitlement pools, link a license key group.
  - ADD LICENSE AGREEMENT: name, license term, link with one feature group



## Create a VSP

- CREATE NEW VSP: name, a **license model**, and category. A VSP can be created from a vendor provided onboarding package or using SDC GUI
- Two xml files are added by SDC under Artifacts folder: vendor-license-model.xml and vf-license-model.xml.
- Modify the VSP, e.g. add additional artifacts (optional step)



## Create a Resource

- Create a VNF / PNF from the VSP
- vendor-license-model.xml → Artifacts/Deployment/VENDOR\_LICENSE
- vf-license-model.xml → Artifacts/Deployment/VF\_LICENSE folder
- Modify the VSP, e.g. add additional artifacts (optional step)



## Design a Network Service

- Create a service template
- Add at least one resource (VNF or PNF) into the service template
- Add additional artifacts, e.g. ECP, workflow. (optional step)



## Testing



## Approve



## Distribution



# LICENSING MANAGEMENT in R7 Guilin

Continue use case analysis for xNF License Management and derive any requirements to ONAP. The aim is for ONAP to support various types (simple, complex, vendor specific) commercial licensing models and use cases. These will be reflected as multiple, optional solutions for ONAP. The use cases we started with include xNF onboarding, PNF introduction/ONAP PnP, VNF instantiation. Further use cases to be analyzed, e.g. usage monitoring for the purpose of invoicing. Based on agreed use cases review relevant ONAP xNF requirements. Possible SW contributions, e.g. in SDC, as well as enhancement of ONAP architecture sequence diagrams.

Key Contacts: Samuli Kuusela (Ericsson), Timo Perala (Nokia)

<https://wiki.onap.org/display/DW/LICENSING+MANAGEMENT>

| R7 CANDIDATE ENHANCEMENTS | IMPACT   |
|---------------------------|--|
| SDC                       | Review and Evaluate xNF Licensing Management enabling multiple optional solutions  |
| Architecture              | Define an architecture that support various types (simple, complex, vendor specific) of commercial licensing models and use cases. It will be reflected as multiple optional solutions for ONAP platform |
| VNF-RQTS                  | Review existing and defining new requirements in the VNF-RQTS project related to the xNF Licensing Management architecture   |
| Plug and Play             | Introduce xNF Licensing Distribution in PnP Use case   |

# PNF PLUG AND PLAY & Licensing Management

## Stage 5: PNF Download & Activation (Vendor Specific)

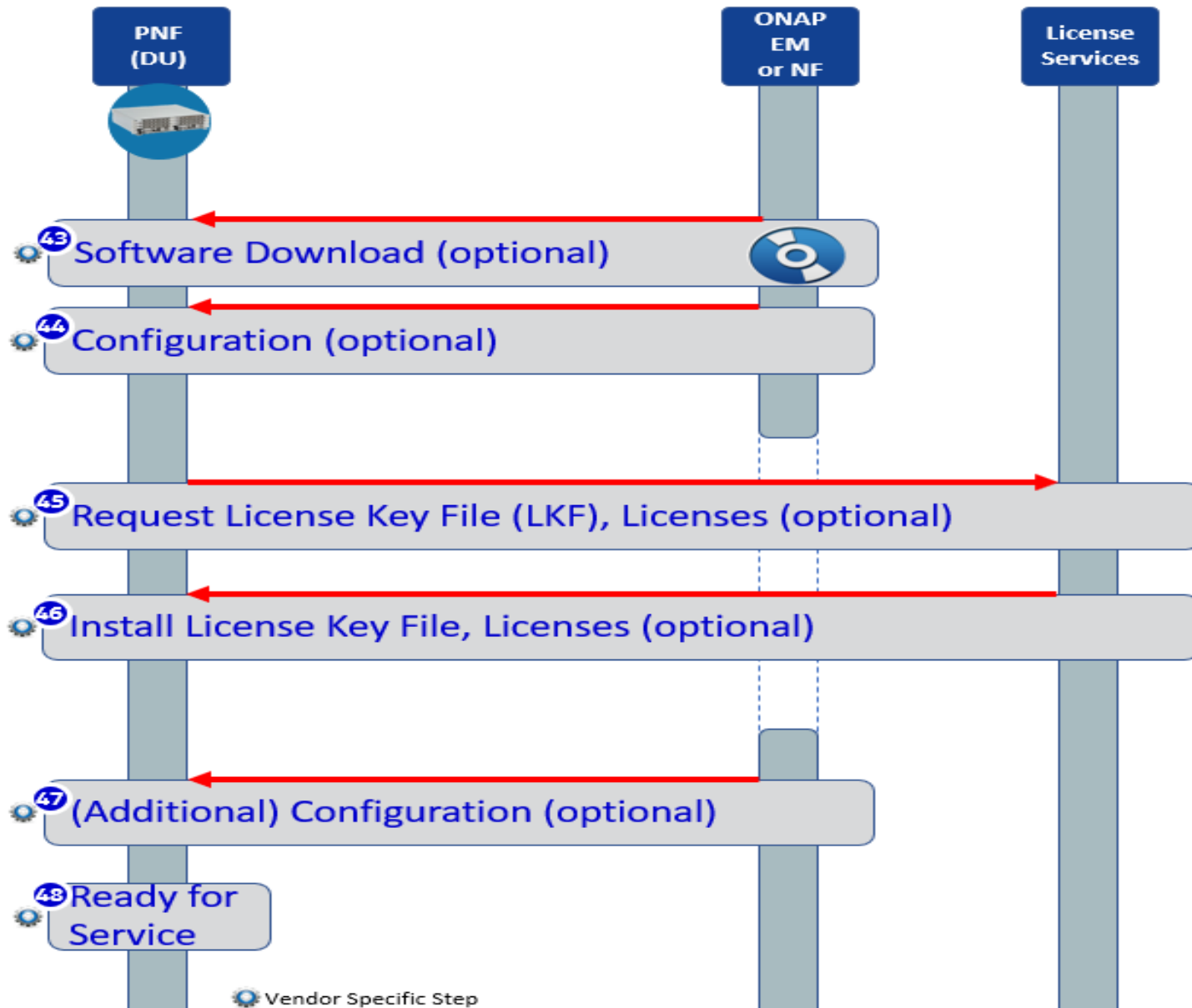



# ONAP/3GPP & ORAN Alignment

- Standard Defined VES Event
- A1 Adaptor Extensions

# ONAP/3GPP & ORAN Alignment in R7 Guilin

Logical Architecture of O-RAN—ONAP as O-RAN compliant SMO

ONAP is concerned with O1, O2 and A1 interfaces ONLY.

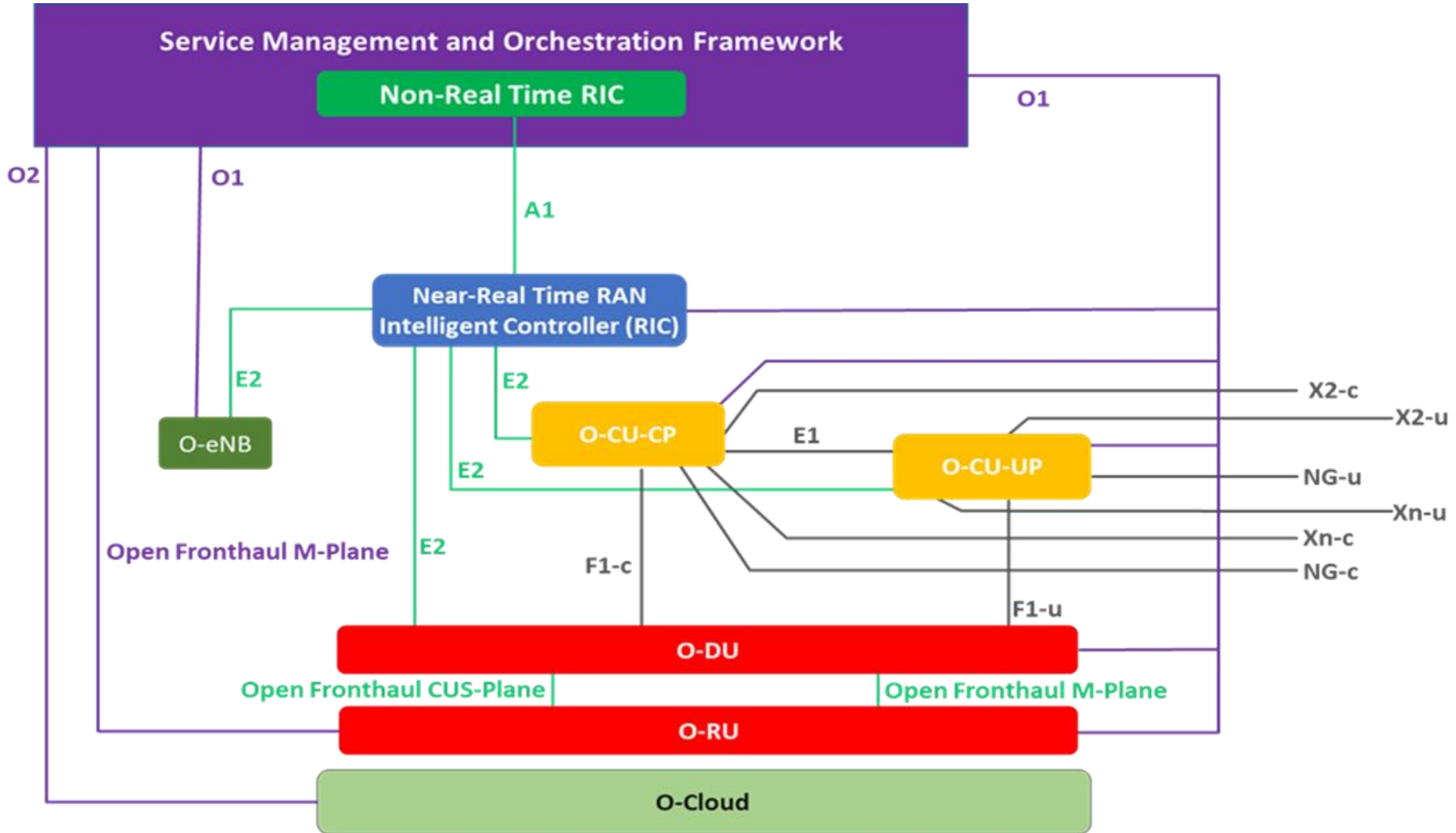

# ONAP/3GPP & ORAN Alignment in R7 Guilin

## **EXECUTIVE SUMMARY -**

-This contribution introduces a new domain in VES, stndDefined, which indicates that the event contains data that conforms to format/schema defined by a separate standards organization<sup>1</sup>. In addition we propose one new field in the VES Common Header to enable further classification of such events, e.g. to support routing of these events to appropriate DMaaP topics. An optional second stage validation is proposed in DCAE prior to acknowledging the event to enhance trouble shooting.

-It is proposed that the first application of this generic capability supports VES encapsulated 3GPP defined notifications as described in 28.532 version 16.3.0 Annex B (informative). The ORAN O1 specification also refers to VES-based 3GPP notifications for several management services, and in those cases is expected to further align with the approach and solution published in 3GPP in a future release.

**BUSINESS IMPACT**- The ability for service providers to deploy ONAP as the SMO in their O-RAN compliant network depends upon ONAP's ability to process VES encapsulated events as defined by 3GPP and ORAN in DCAE and route these events to appropriate DMaaP topics. This proposal, in Guilin, provides the necessary capability for ONAP to process and validate events that are defined using 3GPP schema for the data. The proposal is readily extensible for the support of additional events from 3GPP, ORAN or other standards organizations adding a high degree of flexibility to the ONAP platform.

**BUSINESS MARKETS** - This contribution applies to any Service Provider that wants to use ONAP as an O-RAN compliant SMO or to support 3GPP compliant interfaces and can be leveraged by Service Providers wishing to support events from network functions which are aligned with other standards organizations.

**FUNDING/FINANCIAL IMPACTS** -This contribution helps enable ONAP to be O-RAN and 3GPP compliant which should stimulate contributions from companies that are aligned with O-RAN and 3GPP. There is no new hardware to be procured and no new licenses.

**ORGANIZATION MGMT, SALES STRATEGIES** - This proposal does not affect sales strategies.

1) Standards organization is intended to be interpreted in a broader sense than SDO as defined by ITU, to cover also e.g. joint ventures like 3GPP and open industry fora like the O-RAN Alliance.

# ONAP/3GPP & ORAN Alignment – *Standards Defined* Event in VES

## Guilin Enhancements

- 1) Introduce the ability to receive and route events defined by a standards organization (3GPP, IETF etc.) encapsulated in a VES event to an appropriate DMaaP topic
- 2) Provide the optional capability to provide a second stage of validation within DCAE prior to the DCAE responding to the NF to validate the contents of the event against valid schema defined by the standards organization.
- 3) The first use case supported will be the processing of 3GPP defined notifications defined in TS 28.532 encapsulated in VES events

<https://wiki.onap.org/pages/viewpage.action?pageId=84640792>

## R7 CANDIDATE ENHANCEMENTS

## IMPACT

Add a new domain in DCAE/VES Event Listener, to identify that the data carried in the event is defined by a standards organization. Add a field in the VES Common Header to further identify the routing path for the event.

Additional domain supported in the ENUM in DCAE. VES specification updates to document the new domain. To properly identify this event this enhancement would also introduce a new field in the VES Common Header to facilitate the proper routing of the event. The allowed content of this field would be specified by the standards organization that defined the notification and would not be part of the requirements in the VES specification. The VES specification would provide a reference to the document that contains the standardized information to be populated in that field.

Provide second stage validation of the data carried in the proposed stndDefinedFields structure of the event.

Introduce a schema broker in DCAE that will contain valid standards defined JSON schemas that can be used to validate the data in the standards defined event. Propose to extend existing DCAE CBS component to store valid, standards defined JSON schemas. Propose to extend existing DCAE components to allow for a second stage of validation.



# ONAP/3GPP & ORAN Alignment - A1 Adapter Extension

**Executive Summary** - This requirement enhances the A1 adapter/interface capabilities provided in Rel 6 as part of 5G/ORAN & 3GPP Standards Harmonization requirement ( REQ-38). O-RAN has defined A1 interface specification in the context of the management of 5G RAN elements to provide intent based policies for optimization of the RAN network performance. Planned enhancements for Rel 7 include additional support for managing A1 Policies, multiple A1 targets in the RAN, multi-version support for different A1 targets, and secure TLS communication.

**Business Impact** - Continuing the convergency between ONAP and ORAN initiated in Rel 6, A1 interface can be used by all service providers and avoid duplicate development effort.

**Business Markets** - Enhanced A1 capabilities, once developed, will be useable by any service provider deploying and using ONAP.

**Funding/Financial Impacts** - A1 interface provides a flexible way for the operator to manage wide area RAN network optimization, reducing capex investment needs.

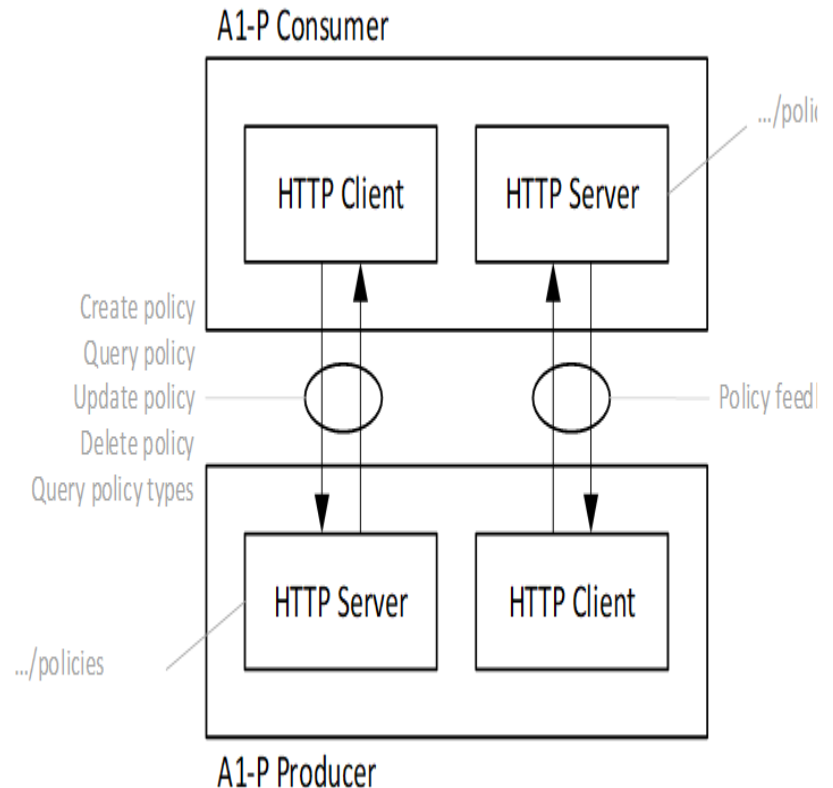

# ONAP/3GPP & ORAN Alignment - A1 Adapter Extension

O-RAN has defined A1 interface specification in the context of the management of 5G RAN elements to provide intent based policies for optimization of the RAN network performance. This requirement enhances the A1 adapter/interface capabilities provided in Rel 6 as part of 5G/ORAN & 3GPP Standards Harmonization requirement ([REQ-38](#)) introducing in ONAP a function for manipulating, maintaining and managing A1 Polices in the RAN network as well as terminating A1 application protocol in ONAP.

Planned enhancements for Rel 7 include additional support for managing A1 Policies, multiple A1 targets in the RAN, multi-version support for different A1 targets, and secure TLS communication.

Key Contacts: Michela Bevilacqua (Ericsson), John Keeney (Ericsson)

U/C DESCRIPTION

Wiki

[TBD](#)

## R7 CANDIDATE ENHANCEMENTS

## IMPACT

A1 Adaptor Extension

Take advantage of the A1 adapter evolution progress in OSC  
Manage A1 policies  
Enable the support of mulitple A1 targets and mulitple versions  
Introduce a secure TLS communication and integrate certificate handling in line with ONAP CMPv2 solution.

R7 Guilin CANDIDATE ENHANCEMENTS



# 5G NETWORK RESOURCE MODEL (NRM)

# 5G Network Resource Model (NRM) in R7 Guilin

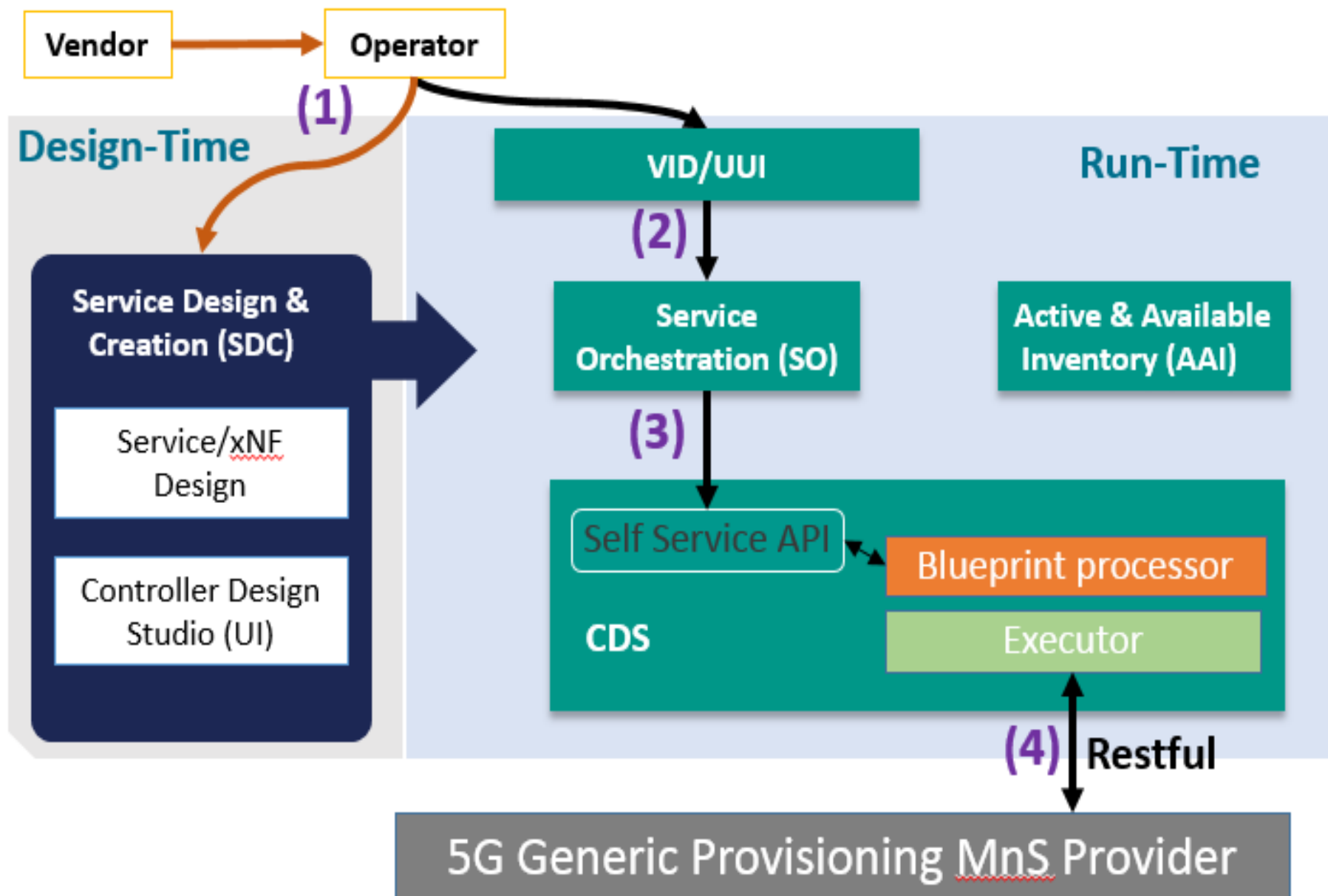

# 5G Network Resource Model (NRM) in R7 Guilin

## New Use Case

- 1) This use case introduces 5G NRM Configuration Management using a RESTful/HTTPS protocol (instead of NetConf). Certainly some corresponding work need to be done in Integration, such as the provisioning MnS provider (Simulator) and documentation. Good news is we complete all implementation and test cases (tested via CLI, actually that is CDS self-service API).

<https://wiki.onap.org/display/DW/5G+Network+Resource+Model+%28NRM%29+Configuration+in+R7>

| R7 CANDIDATE ENHANCEMENTS | IMPACT  |
|---------------------------|---|
| SO                        | Add new NRM related data types, corresponding PNF packages and BPMN enhancements as well<br>Use several NR NRM IOCs for demonstrations and enhance the PNFD model<br>BPMN support for NRM configuration |
| SO                        | Support SO service/instance management API for NRM configuration<br>Modify or Add additional SO NB APIs<br>Define corresponding NRM IOCs in SO and BBs  |



# CONFIGURATION & PERSISTENCY SERVICE (C&PS)

# CONFIGURATION & PERSISTENCY SERVICE in R7 Guilin

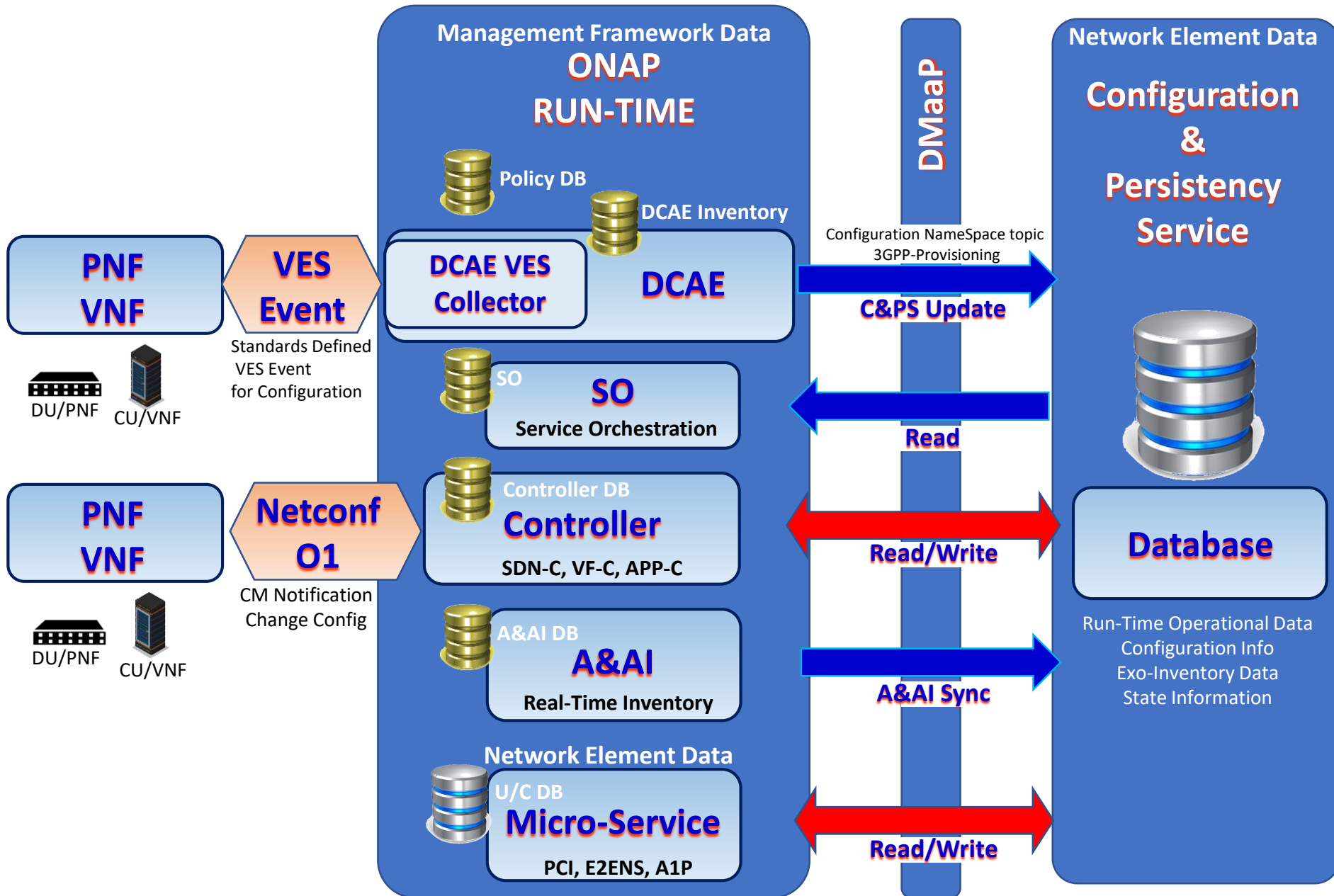

# CONFIGURATION & PERSISTENCY SERVICE in R7 Guilin

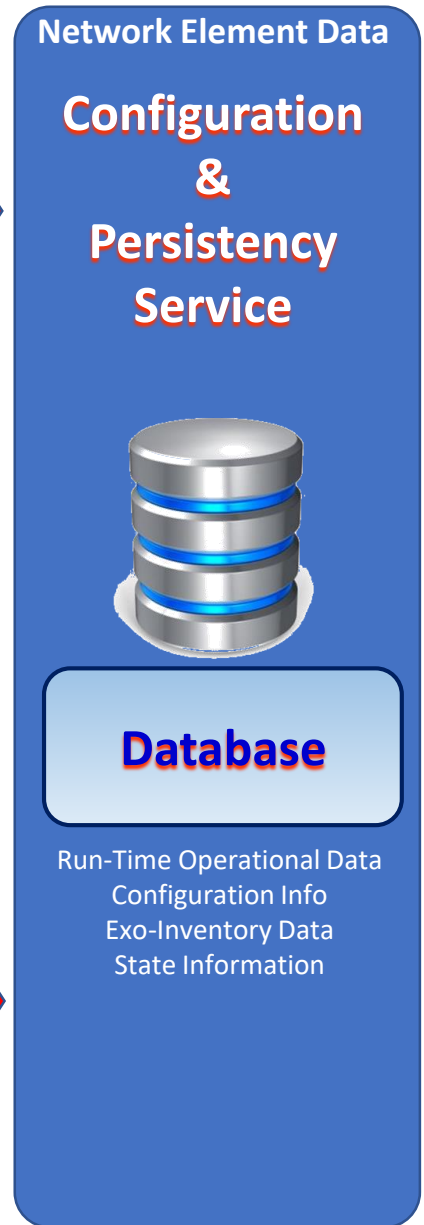
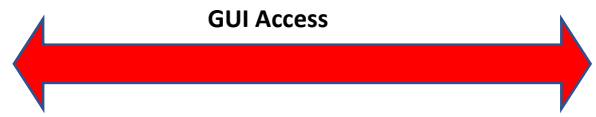
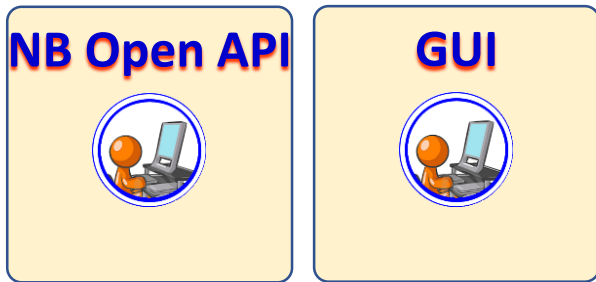
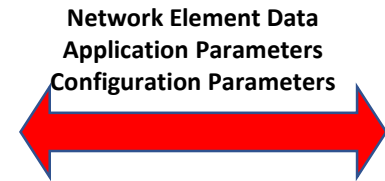
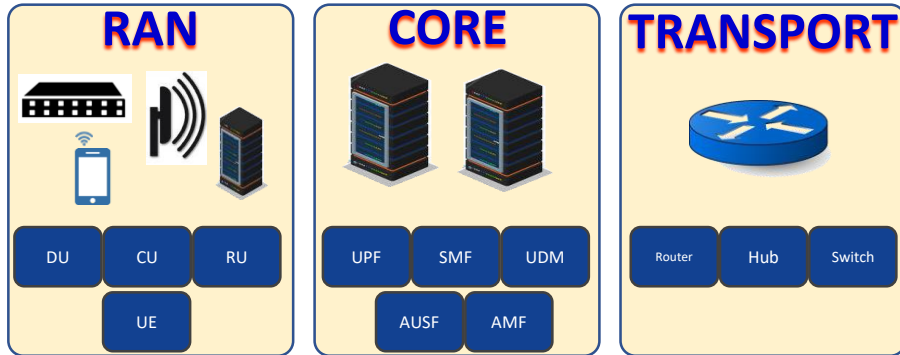

## ONAP Micro-services, POCs & Use Cases

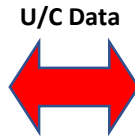
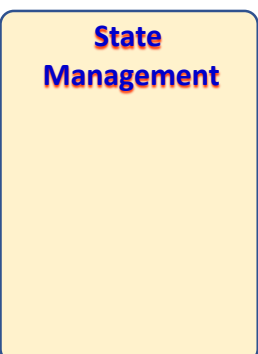
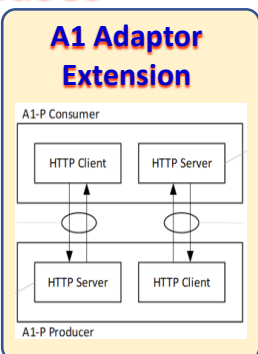
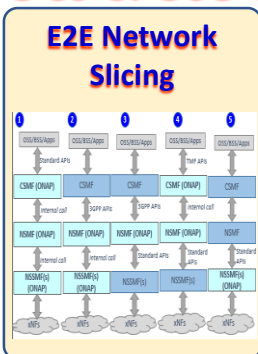
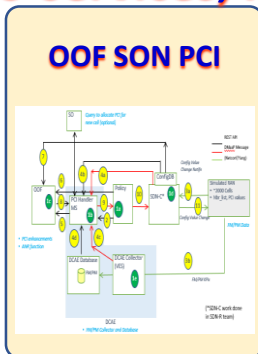
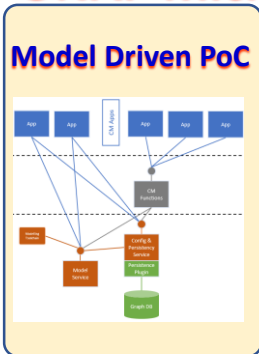



# CONFIGURATION & PERSISTENCY SERVICE in R7 Guilin



ONAP Architecture  
Version 4.0.10  
Date: May 16th, 2019

OSS / BSS / Other

Legend Design Orchestration & Management Operations

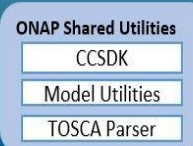
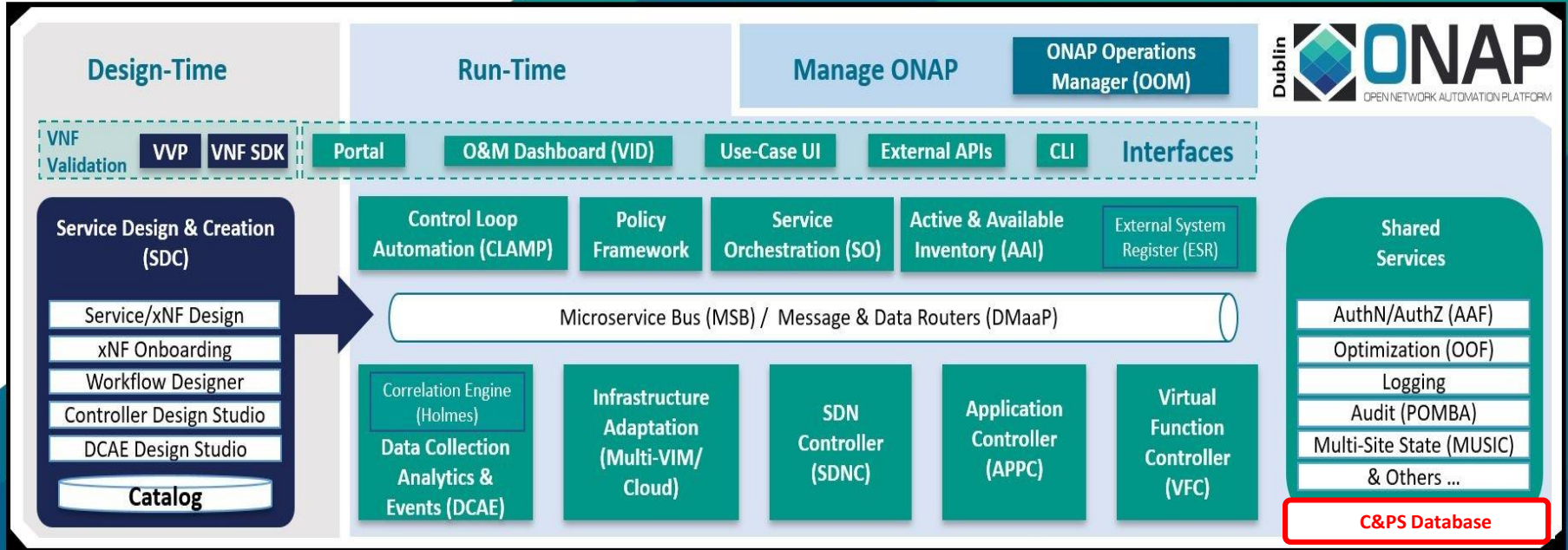

Managed Environment

# CONFIGURATION & PERSISTENCY SERVICE Overview

## Configuration & Persistency Service (C&PS)

The Configuration & Persistency Service is a new platform component that is designed to serve as a data repository for Run-time data that needs to be persistent. As a stand-alone ONAP component, this project provides data layer services to other ONAP platform components and use cases that require persistent configuration or operational data. The R6 development will be enhanced as well.

**REPOSITORY** – The C&PS will store Network Element Configuration, State information, and Run Time data in its internal database.

**DATA LAKE** – The C&PS is designed to be a common services data layer for micro-services to access & store run time data.).

### ARCHITECTURE REQUIREMENT IDENTITY – ROW 25

[AR-0024-R7-052020 Run Time Configuration Database / Data Persistency Service Project](#) Benjamin Cheung, Joanne Liu Rudel, Tony Finnerty [xNF](#)

**EXECUTIVE SUMMARY** - The RunTime Configuration Database / Data Persistency Service is a new platform component that is designed to serve as a data repository for Run-time data that needs to be persistent. As a stand-alone ONAP component, this project provides data layer services to other ONAP platform components and use cases that require persistent configuration or operational data. The R6 development will be enhanced as well.

**BUSINESS IMPACT** - The ability for service operators to visualize and manage data in a RAN network (PNFs, VNFs, and logical constructs) with ONAP is a critical business function because they are key Life Cycle Management (LCM) and OA&M operations. The project has business impacts to enhance the operation of data-handling within ONAP by providing efficient data layer services.

**BUSINESS MARKETS** - This project applies to any domain (wireless, transport, optical, and wireline) that ONAP may manage. It is not a market or geographical specific capability. It is expected that scaled ONAP installations such as Edge & Core ONAP deployments will also deploy the database across each installation.

**FUNDING/FINANCIAL IMPACTS** - This project represents a large potential Operating Expense (OPEX) savings for operators because of the ability to configure networks saving time and expenses.

**ORGANIZATION MGMT, SALES STRATEGIES** - There is no additional organizational management or sales strategies for this use case outside of a service providers "normal" ONAP deployment and its attendant organizational resources from a service provider.

# CONFIGURATION & PERSISTENCY SERVICE in R7 Guilin

Wiki

<https://wiki.onap.org/pages/viewpage.action?pageId=81406119>

R7 Guilin NEW COMPONENT CAPABILITIES

| R7 NEW COMPONENT CAPABILITIES ( <a href="#">CC-SDK R6 extension</a> ) | IMPACT DESCRIPTION  |
|---|---|
| C&PS Database Development (New Development) [CC-SDK]                  | API Updates<br>Interface to C&PS Database.<br>Initial Database Setup / Database schema setup  |
| Controller (SDN-C)  | 1. Yang model used C&PS (hosted by controller).<br>2. NetConf “path” - PNF through Netconf to update database.  |
| DCAE (Dependency)   | <b>1. Using</b> the 3GPP StdDefined VES Event* to send Configuration data<br><b>2. Using</b> VES listener update/DCAE Pathway for 3GPP-Provisioning notification<br><b>3. Using</b> DMaaP Development to publish on 3GPP-Provisioning NameSpace |
| Modeling  | Design time support for dynamic database schema setup (run time)  |
| A&AI (Dependency)   | A&AI Element Sync (new/delete xNF, initial “getall”)<br>( <b>Using</b> A&AI) Query Retrieve & A&AI DMaaP Test only  |
| VNF-REQ (Dependency)  | (Dependency) VES requirements for VES updates.  |

\*3GPP TS28.532 Annex B provides valid name spaces and details.

# CONFIGURATION & PERSISTENCY SERVICE in R7 Guilin

Wiki

<https://wiki.onap.org/pages/viewpage.action?pageId=81406119>

R7 Guilin NEW COMPONENT CAPABILITIES

| R7 NEW COMPONENT CAPABILITIES ( <b>R7 &amp; Beyond</b> ) | IMPACT DESCRIPTION   |
|--|--|
| New C&PS Stand-alone Platform Component                  | Configuration & Persistency Service (CPS) would be its own Platform Component in R7 Project proposal<br><a href="https://wiki.onap.org/pages/viewpage.action?pageId=71834216">https://wiki.onap.org/pages/viewpage.action?pageId=71834216</a><br>New platform project – DMaaP listener, Absorb SDC Service CSAR Pkg (DMaaP) Database schema setup<br><br>R7 Objectives to support the Access & Support for initial Use Cases (see Roadmap slide) |
| Model Driven POC using C&PS                              | A Model Driven C&PS PoC to demonstrate C&PS functionality<br>Then full project proposal in R8 Honolulu   |

\*3GPP TS28.532 Annex B provides valid name spaces and details.

# R7 Model Driven C&PS PoC > Model Driven Configuration

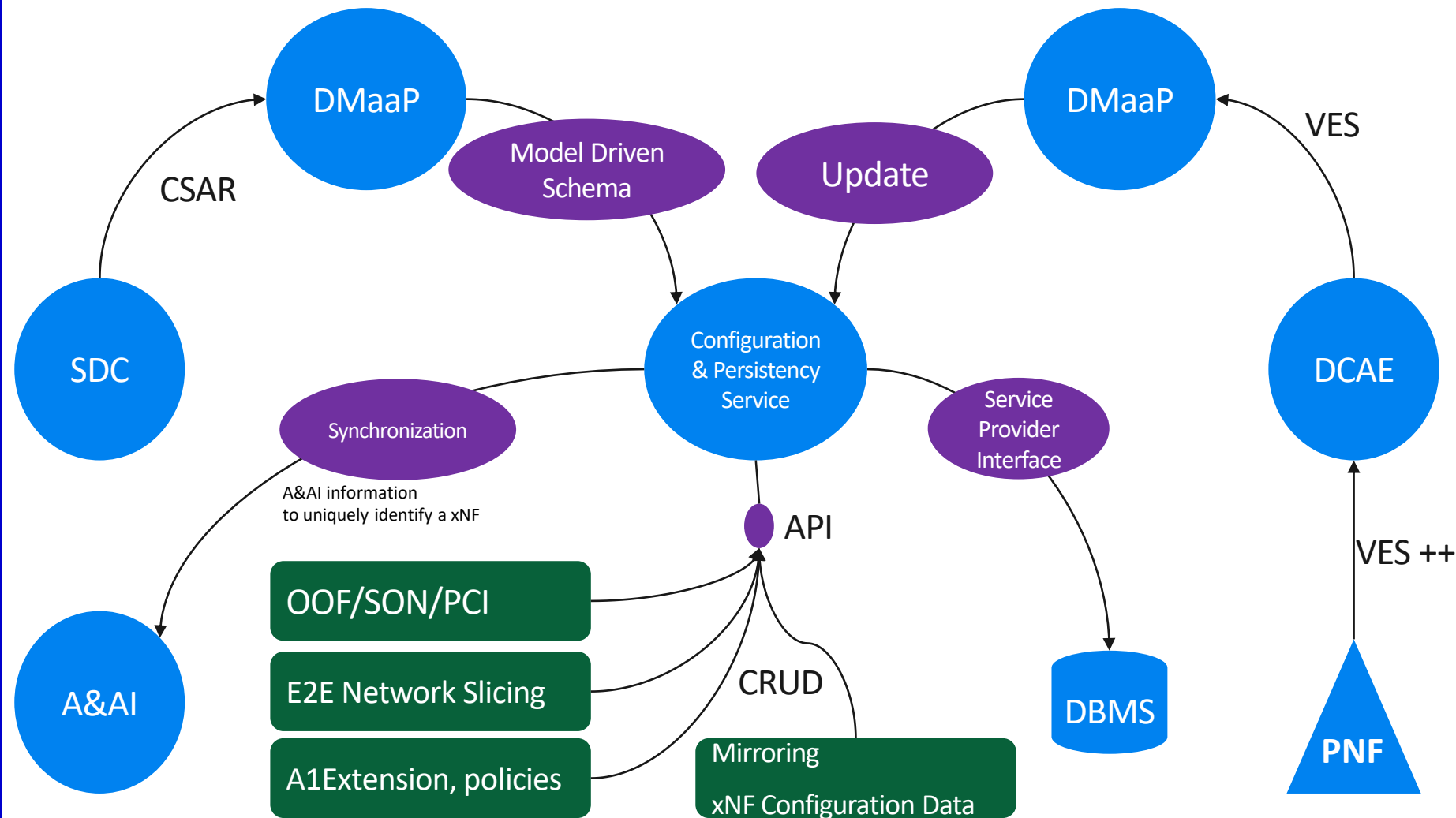
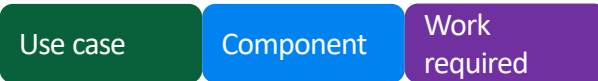

# C&PS - INTERFACES & APIs

## R7 Guilin Interfaces Impacts

| R7 Interfaces                      | IMPACT  |
|------------------------------------|---|
| DCAE – VES Listener (Dependencies) | (USES Interface) this project <b>DEPENDS</b> on the 5G Harmonization work to develop the stndDefined VES 3GPP-Configuration (Namespace) Notification work |
| Controller (Dependencies)          | (USES Interface) Controller Interfaces to receive Yang models (SDC) used by the project to setup database   |
| A&AI (Dependencies)                | (USES Interface) A&AI Interface to get new/delete xNF, initial “getall”<br>Listening to A&AI updates on DMaaP   |
|                                    |   |

## R7 Guilin APIs Impacts

| R7 API                                   | IMPACT   |
|--|--|
| New API for C&PS (Stand-alone component) | <p><b>NEW API</b> for C&amp;PS for uS to access C&amp;PS internal databases</p> <p><b>NEW API</b> to allow access to the data model</p> <ul style="list-style-type: none"> <li>- Reflects Yang model to interpret data that is stored (constraints / Model driven)</li> <li>- To Navigate data stored, based on Yang-model provided by NFs.</li> <li>- C&amp;PS to any entity to retrieve/store info to C&amp;PS database</li> </ul> |
|  |  |

# C&PS - MODELING IMPACTS

| R7 Model                   | IMPACT  |
|----------------------------|---|
| Platform Information Model | Data being consumed & used – is the design time yang model that in onboarded that will be used to setup the C&PS database.  |
| Internal C&PS Model Work   | Model-driven<br><br>Common Foundation model – to “hang” tech specific information from.<br>Common constructs<br>API representation on C&PS API.<br>Model -> Design time<br>“Loading” from A&AI ... needs to be modeled. |

# C&PS Roadmap & Evolution across releases

## Configuration & Persistency Service (CPS) Roadmap – What will be delivered when

R7 Guilin

R8 Honolulu

Rx Future

In R7 what are develop

### CPS FUNCTIONALITY:

- Store Real-Time Configuration Data
- Data Update
- Access Control

### USE CASES:

“Configuration Data”  
SON/OOF/PCI U/C,  
5G E2E Network Slicing  
A1 Policies

### R7 Requirement Proposal

<https://wiki.onap.org/display/DW/Guilin+release+-+functional+requirements+proposed+list#Guilinreleasefunctionalrequirementsproposedlist-RunTimeConfigurationDatabase/DataPersistencyServiceProject>

December 2020

In R8 what are develop

### CPS FUNCTIONALITY:

- Data Recovery
- Model Adaption (Dynamic Schema)

July 2021

Rx (future) what are develop

### CPS FUNCTIONALITY:

- Data Auditing
- Topology Traversal
- Data History
- Roll-Back
- Data Syncing
- Performance Optimization (Scaling)





# END TO END NETWORK SLICING

# NETWORK SLICING in R7 Guilin

**Objective:** Demonstrate e2e slice design, creation, activation, deactivation and termination - including **RAN, Core and Transport** slice sub-nets. Demonstrate KPI monitoring, simple Closed Loop Control & Intelligent Slicing.

Lifecycle of a Network Slice Instance

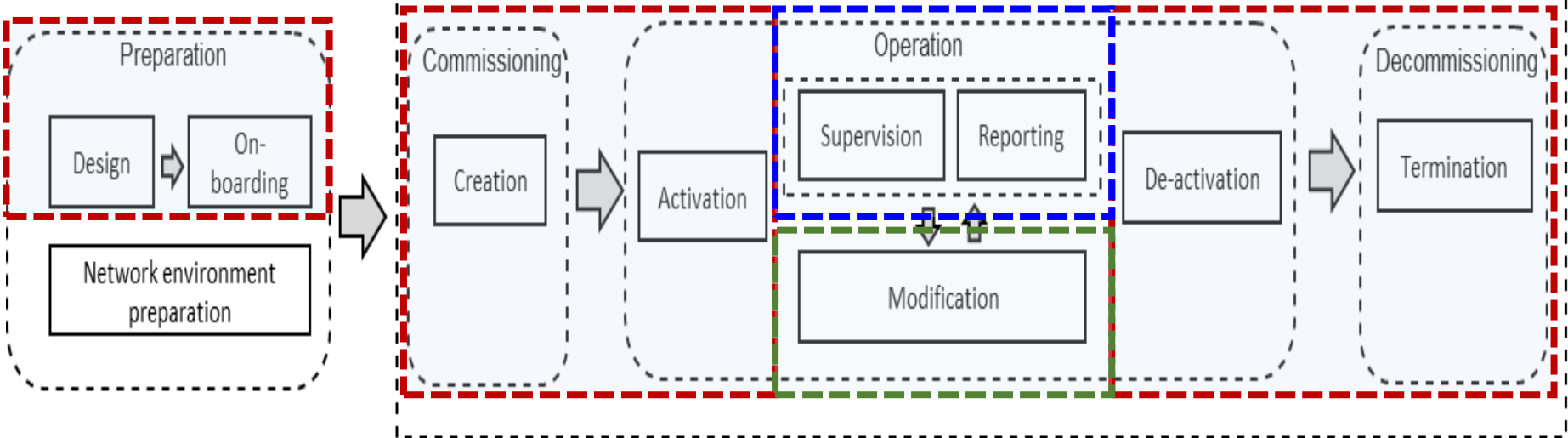

Ref.: 3GPP TS 28.530

 Scope for Frankfurt (with enhancements)

 Additional scope for Guilin (under discussion)

 Initial steps in Guilin (under discussion)

- **Design and pre-provision:** Creation of necessary slice/slice sub-net templates.
- **Creation, activation, deactivation and termination** of NSI, including its constituent slice sub-nets (RAN, Core and Transport).

# NETWORK SLICING in R7 Guilin

R7 Network Slicing is looking to provide: (1) a full E2E Slicing solution involving RAN and Transport NSSMF, and connecting to external Core NSSMF. (2) KPI monitoring and Closed Loop Control (3) Intelligent Slicing (4) Standardized interfaces (5) Model enhancements, AAI schema updates 1:1 mapping between NSI and NSSI

<https://wiki.onap.org/display/DW/E2E+Network+Slicing+Use+Case+in+R7+Guilin>

| ENHANCEMENTS  | DESCRIPTION  |
|---------------|--|
| SDC           | Enhance CST, NST, design of RAN, Transport NSSTs, KPI monitoring                             |
| UUI           | Support of CSMF, NSMF, KPI monitoring, Time base service activation                          |
| EXT API       | Support of standard interfaces for CSMF, NSMF and NSSMF                                      |
| SO            | NSSMF RAN/Transport subnets. Interface standardization, External Core NSSMF, CLC             |
| OOF           | NSI selection, NSSI selection, resource reallocation in RAN transport subnets, PM data       |
| DCAE          | Data lake, KPI data. uS KPI, Intelligent Slicing, VES enhance, Store AF data                 |
| Policy        | Control loop enhancement, Config. Policies for OOF, SO, DCAE                                 |
| SDN-C         | NSSMF functionality for RAN & Transport, CLC functionality.                                  |
| CDS           | API mapping on SB interfaces   |
| A&AI          | Schema updates for network slicing, net modes for NSI, NSSI, RAN & transport slice inventory |
| C & P Service | RAN configuration data (cell level initial and network slicing related)                      |

U/C DESCRIPTION

Wiki

R7 Guilin CANDIDATE ENHANCEMENTS

# R7 Guilin PNF Support U/C SUMMARY

| 5G USE CASE                                | DESCRIPTION   | Req vs U/C   |
|--|---|--------------|
| <b>PNF PRE-ONBOARDING &amp; ONBOARDING</b> | PNF Package delivery, Pre-onboarding and PNF Onboarding via SDC.  | Requirements |
| <b>PNF PLUG AND PLAY</b>                   | PNF PnP handles the PNF discovery and registration by ONAP during installation & commissioning. PRH (PNF Registration Handler) enhancements | E2E Use Case |
| <b>xNF S/W UPGRADE</b>                     | PNF Software upgrade to update the software on a PNF. Use of Ansible/NetConf direct to PNF.   | Requirements |
| <b>CMPv2</b>                               | Certificate Management Protocol<br>(Will be presented in its own Lecture at the Virtual Face to Face)                                       | Requirements |



# PNF PREONBOARDING / ONBOARDING

# PNF PRE-ONBOARDING/ONBOARDING U/C OVERVIEW

**1 PNF Package Delivery:** Vendor creates & delivers PNF Package with PNF artifacts

**2 PNF Pre-Onboarding:** VNF-SDK ( ) to (create) PNF Onboarding Package & validates of PNF onboarding package

**3 PNF Onboarding package:** Package loaded

**4 SDC:** NF OB Package > SDC catalog

**5 ONAP RT Components:** Ingest and use CSAR package

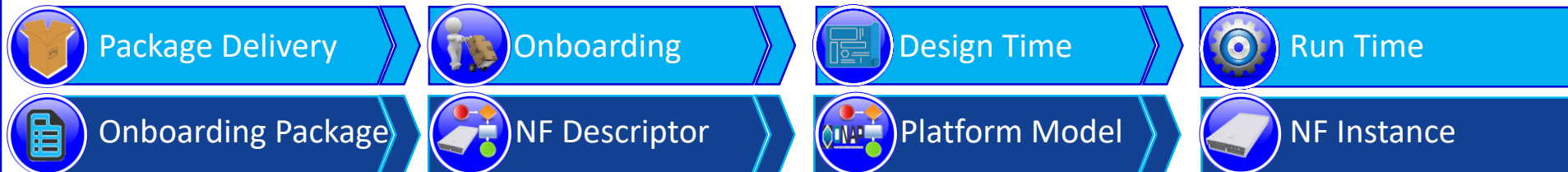
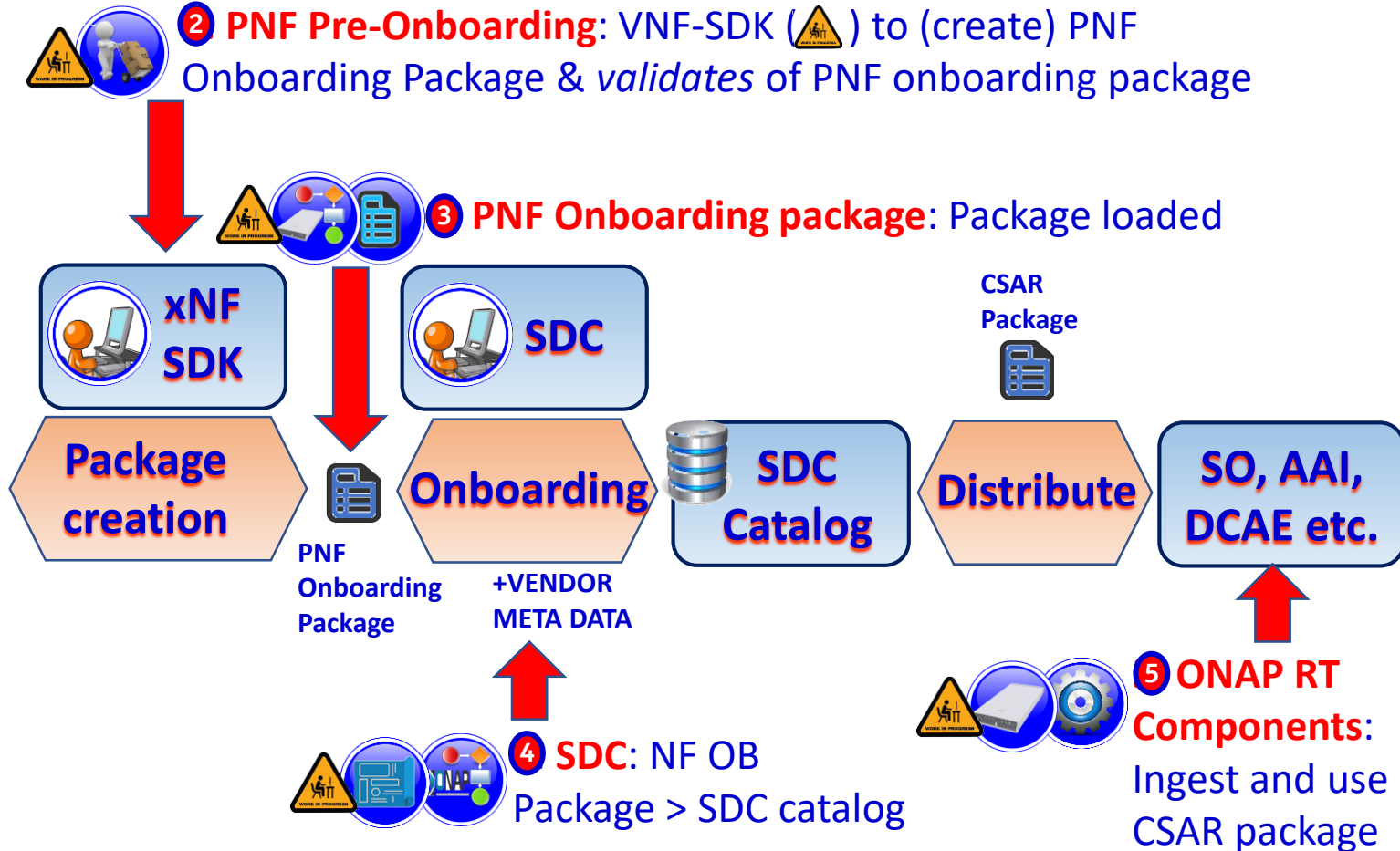
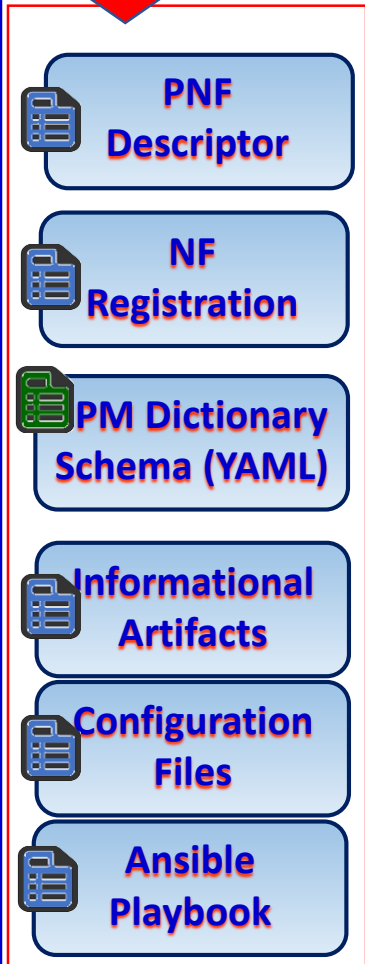

# PNF PRE-ONBOARDING – Overview

This Use Case will introduce the support for PNF pre-onboarding (PNF Package, PNF descriptor support) and PNF onboarding (SDC, Design Time, PNF-SDK).  
PNF Package delivery by vendor (during Pre-onboarding activities) and PNF Onboarding via SDC in Dublin.

## ARCHITECTURE REQUIREMENT IDENTITY – ROW 19

[AR-0018-R7-052020](#) [Guilin release - functional requirements proposed list#R7PNFONBOARDING/PRE-ONBOARDINGVNF-SDKVALIDATION](#)  
Benjamin Cheung, Damian Nowak, Zu Qiang (Ericsson) [xNF](#)

**EXECUTIVE SUMMARY** - This requirement enhances the PNF Pre-onboarding use case. This requirement introduces package security Option2 improvements on Signature per artifact on the Vendor delivered package as defined in ETSI NFV SOL004 v2.7.1. The validation of onboarded PM dictionary data based on schema information will be done. (What is added from existing functionality)?

**BUSINESS IMPACT** - The enhancement to Onboarding & Pre-onboarding is a critical business function because they are vital to design-time operation to properly onboard vendor packages.

**BUSINESS MARKETS** - This project applies to any domain (wireless, transport, optical, and wireline) that ONAP may manage.

**FUNDING/FINANCIAL IMPACTS** - The PNF Onboarding & Pre-onboarding use case has Operating Expense (OPEX) savings for operators because of the ability to saving time and expenses during installation and commissioning of PNF resources.

**ORGANIZATION MGMT, SALES STRATEGIES** - There is no additional organizational management or sales strategies for this use case outside of a service providers "normal" ONAP deployment and its attendant organizational resources from a service provider.

# PNF PRE-ONBOARDING – Overview

ETSI GS NFV-SOL 004 V2.7.1 (2019-12)



## Network Functions Virtualisation (NFV) Release 2; Protocols and Data Models; VNF Package and PNF Archive specification

### 5.2 VNF package manifest and certificate files

In option 1 (see clause 5.1) the manifest file provides the VNF package integrity and authenticity assurance. In this option the manifest contains the digests (hashes) for each individual file locally stored within the VNF package or referenced from it. Each file related entry of the manifest file includes the path or URI of the individual file, the hash algorithm and the generated digest. A consumer of the VNF package shall verify the digests in the manifest file by computing the actual digests and comparing them with the digests listed in the manifest file.

In option1 the VNF package authenticity is ensured by signing the manifest file with the VNF provider private key. The digital signature is stored in the manifest file itself (see clause 5.3). The VNF provider shall include an X.509 certificate [8] in the VNF Package. The certificate shall be either placed in a certificate file with extension .cert or, if the chosen signature format allows it, the certificate may be included in the signature container itself. The certificate provides the VNF provider public key.

In option 2 (see clause 5.1), the VNF package authenticity and integrity is ensured by signing the CSAR file with the VNF provider private key (option 2 in clause 5.1). The digital signature is stored in a separate file. The VNF provider shall also include an X.509 certificate. The certificate may be included in the signature itself if the signature format allows it or in a separate file. The signature and certificate files shall be siblings of the CSAR file, i.e. placed in the same folder in the parent archive. The signature file shall have an extension .cms and the same name as the CSAR file. Naming conventions for the certificate file are specified in clause 4.3.6.

In this alternative (option 2 in clause 5.1) it is not required to include digests (hashes) per each individual file or artefact in the manifest file. A consumer of the VNF package can verify the signature of the complete CSAR package with the VNF provider public key.

Table 5.2-1 summarizes the characteristics of the two possible options for integrity assurance.

Table 5.2-1: Options for VNF Package integrity assurance: summary of characteristics

| Options  | Digest per artifact | Signature per artefact | Support external artifacts | Signature as part of the manifest file | External Signature file for the whole CSAR | Certificate may be part of the signature | Certificate may be in a separate file |
|----------|---------------------|------------------------|----------------------------|--|--|--|---------------------------------------|
| Option 1 | Yes                 | Yes (mandatory)        | Yes                        | Yes                                    | No   | Yes                                      | Yes                                   |
| Option 2 | No                  | Yes (mandatory)        | No                         | Yes                                    | Yes  | Yes                                      | Yes                                   |

The X.509 certificate may contain one single signing certificate or a complete certificate chain. The root certificate that may be present in this X.509 certificate file shall not be used for validation purposes. Only trusted root certificate pre-installed in NFVO shall be used for validation (see clause 5.1).



# PNF PRE-ONBOARDING/ONBOARDING in R7 Guilin

Wiki

<https://wiki.onap.org/pages/viewpage.action?pageId=81407399>

R7 Guilin NEW COMPONENT CAPABILITIES

## R7 NEW COMPONENT CAPABILITIES

## IMPACT DESCRIPTION

VNF-SDK (PNF-SDK)

### ETSI SOL004 alignment:

- Package Validation enhancements notable Package security (option 2 security on entire package)
- Signatures Hashchecks per artifact (applicable for both Option 1 & 2) – in R4/R5/R6 signature Hashcheck may exist for option 1.
- VNF-SDK adding Option 2

# PNF PRE-ONBOARDING/ONBOARDING INTERFACES & APIs

R7 Guilin Interfaces Impacts

| R7 Interfaces | IMPACT  |
|---------------|---|
| (None)        | (The R7 work is entirely internal to VNF-SDK) |
|               |   |

R7 Guilin APIs Impacts

| R7 API | IMPACT  |
|--------|---|
| (None) | (The R7 work is entirely internal to VNF-SDK) |
|        |   |

# PNF PRE-ONBOARDING/ONBOARDING MODELING IMPACTS

R7 Guilin Modeling Impacts

| R7 Model | IMPACT |
|----------|--------|
| (None)   | (None) |
|          |        |



# PNF PLUG AND PLAY

# PNF PLUG AND PLAY U/C Overview

Design Time

1



## PNF Modeling

Resources Definition/Services Definition  
SDC: PNF (physical element) Modeling  
Distribution of types

2



## PNF Instance Declaration

PNF Infrastructure Service Declaration  
First part of PNF instantiation  
PNF A&AI Entry created

15 16 17 18 19 20 21 22



3



## PNF Boot-strapping

PNF Powers up and Boot-straps  
PNF performs a "Plug and Play" procedure  
Equipment vendor proprietary steps

4



## PNF Contacts ONAP

PNF connects to ONAP via a Registration Event  
PNF Registration Handler (PRH) processes the event

25 26 27 28 29 30 31

5



## PNF Activation

Connection points configured  
Second part of PNF service instantiation  
PNF configured and ready to provide service

34 35 36 37 38 39 40 41 42

Run-Time (Instances)

# PNF PLUG AND PLAY – Overview

This Use Case will continue PNF Plug and Play development started in R3 Casablanca. Functionality that was started but not completed, and introduce some enhancements to improve Plug and Play operation.

## ARCHITECTURE REQUIREMENT IDENTITY – ROW 17

[AR-0016-R7-052020](#) [R7PNFPLUG&PLAYBUILDINGBLOCK/WORK-FLOWMANAGEMENT](#) Benjamin Cheung, Damian Nowak [xNF](#)

**EXECUTIVE SUMMARY** - This requirement will augment the work-flow to building block management within SO for Plug and Play operation. The continues the work started in R6. The description of the "base" work which will be enhanced is shown in the wiki: [PNF PLUG and PLAY in R6 Frankfurt](#)

**BUSINESS IMPACT** - The enhancement to Plug and Play operation in ONAP is a critical business function because they enhance installation and commissioning activities.

**BUSINESS MARKETS** - This project applies to any domain (wireless, transport, optical, and wireline) that ONAP may manage.

**FUNDING/FINANCIAL IMPACTS** - The plug and play project has Operating Expense (OPEX) savings for operators because of the ability to saving time and expenses during installation and commissioning and contributes towards ZTM (Zero touch management).

**ORGANIZATION MGMT, SALES STRATEGIES** - There is no additional organizational management or sales strategies for this use case outside of a service providers "normal" ONAP deployment and its attendant organizational resources from a service provider.

# PNF PLUG AND PLAY – Overview

## Proposed building blocks

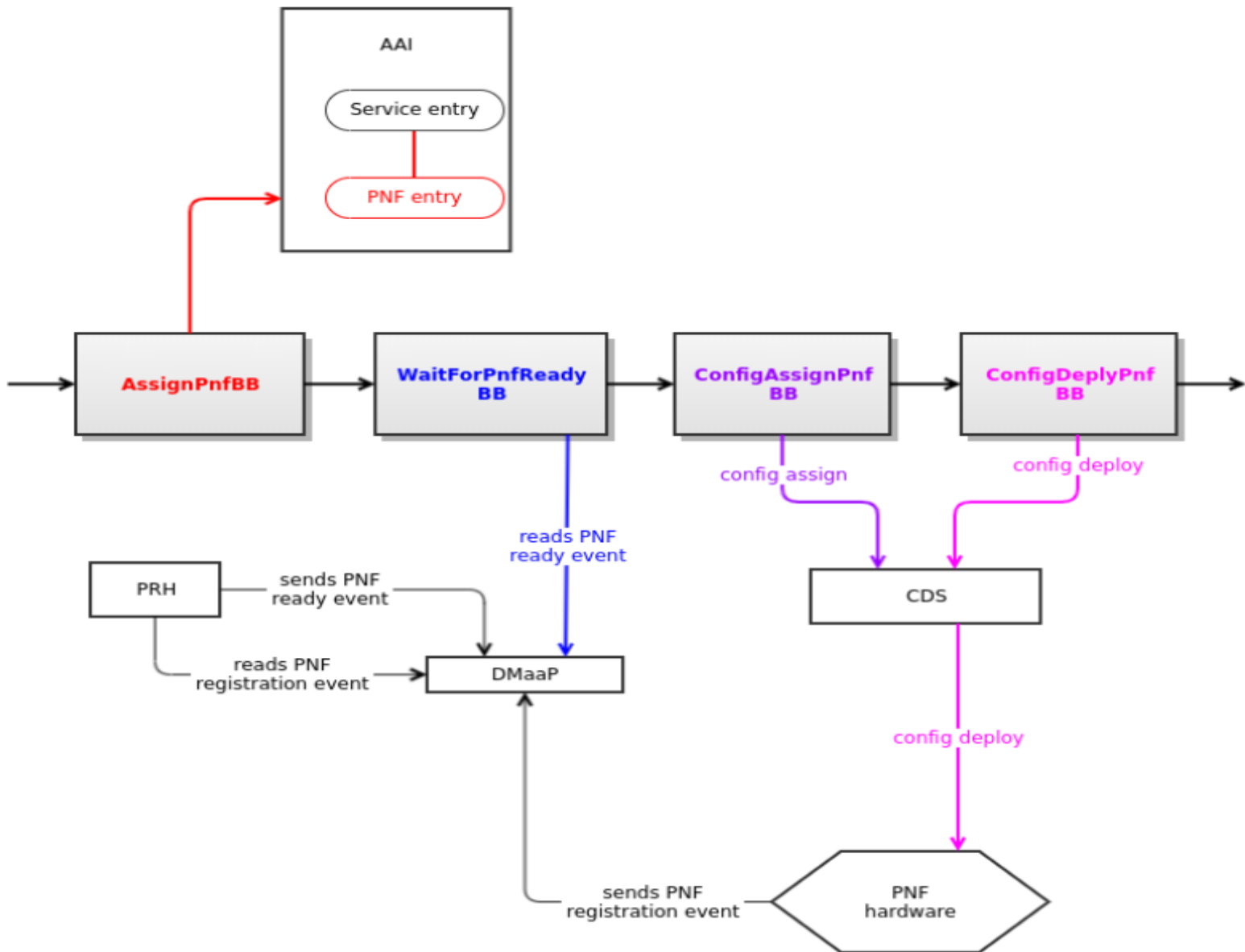

# PNF PLUG AND PLAY – Licensing Management Enhancement

## Stage 5: PNF Download & Activation (Vendor Specific)

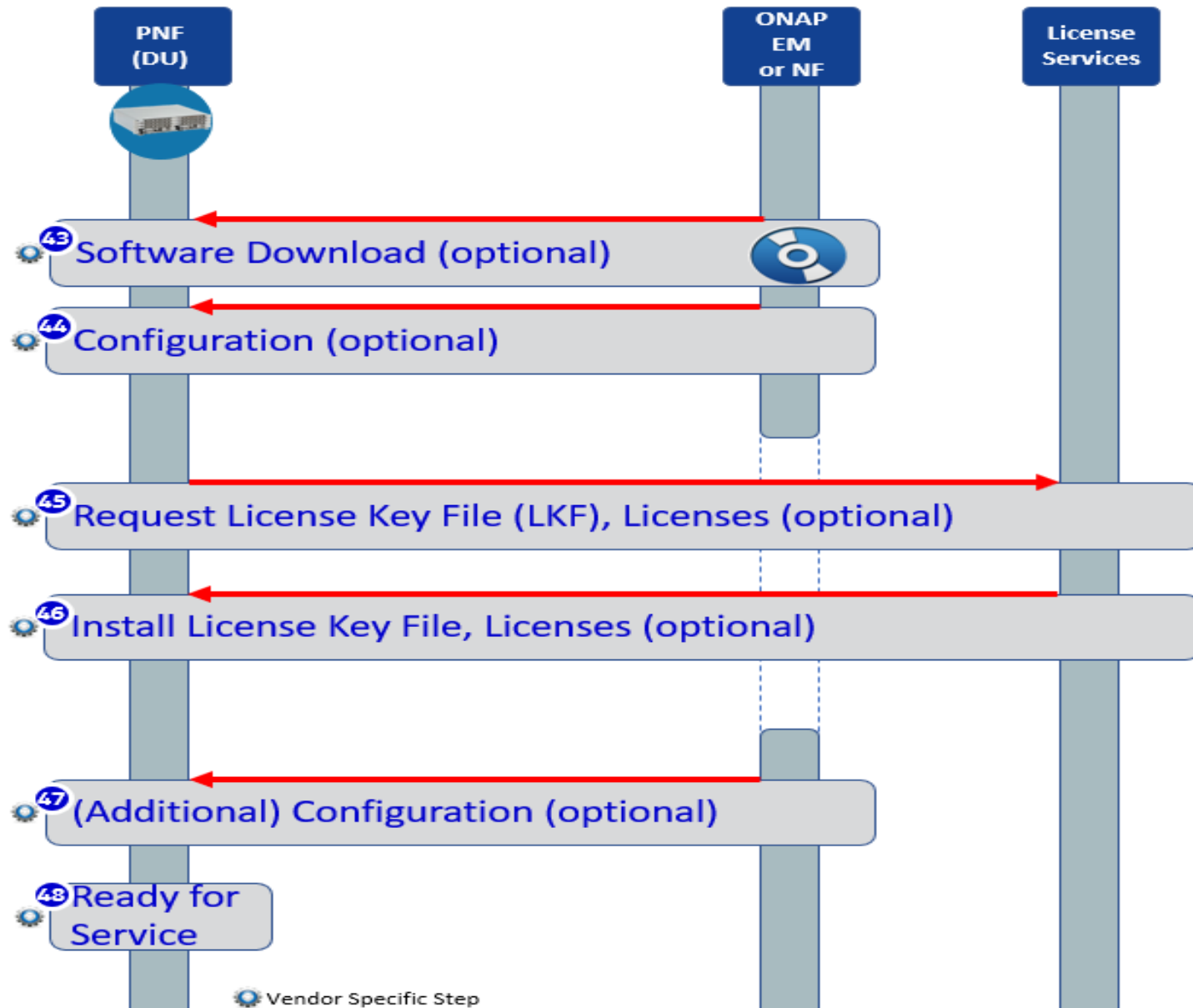



# PNF PLUG AND PLAY for R7 Guilin

Wiki

<https://wiki.onap.org/display/DW/R7+PNF+Plug+and+Play+PnP>

R7 Guilin NEW COMPONENT CAPABILITIES

| R7 NEW COMPONENT CAPABILITIES     | DESCRIPTION  |
|-----------------------------------|--|
| AAF / CMPv2 (Dependency)          | (Dependent CMPv2 work) Security enrollment enhancements integration with DCAE. Code merging with OOM. Using CMPv2. R6 REQ-140<br>CMP client/server work done; Integration work<br>(see later slides) |
| SO (Integration)                  | (Ericsson) Service configuration to PNF by controller ( <b>Step 37</b> ) NetConf.<br>Impact to inventory (A&AI)<br>BB based W/F connected to Configuration Steps to integrate & complete.            |
| Licensing Management (Dependency) | (Dependency) Enhancements for requesting License Key File (LKF) & Licenses from License Service (message exchange)<br>Flow still being defined by the Use Case team                                  |

# PNF PLUG AND PLAY INTERFACES & APIs

## R7 Guilin Interfaces Impacts

| R7 Interfaces | IMPACT   |
|---------------|--|
| AAF           | (Dependency / Cross Interaction with CMPv2 work) – See CMPv2 Requirement                       |
| SO            | (Integration work only) BB based W/F connected to Configuration Steps to integrate & complete. |

## R7 Guilin APIs Impacts

| R7 API | IMPACT  |
|--------|---|
| SO     | (Integration work) BB based W/F connected to Configuration Steps to integrate & complete. |

# PNF PLUG AND PLAY MODELING IMPACTS

R7 Guilin Modeling Impacts

| R7 Model | IMPACT |
|----------|--------|
| (None)   | (None) |
|          |        |



# PNF SOFTWARE UPGRADE

# xNF S/W UPGRADE / with schema update in R7 Guilin

## ➤ Design time

- Updating the xNF resource template using vendor provided new onboarding package
- Updating and distributing the network service template with the updated resource template

## ➤ Run Time: executing a new service level workflow

- Upgrading a service instance and its resource instances based on the updated templates
- Updating the xNF schema (e.g. software version, artifacts) at xNF instance software upgrade completion
- Updating the network service schema at network service upgrade completion

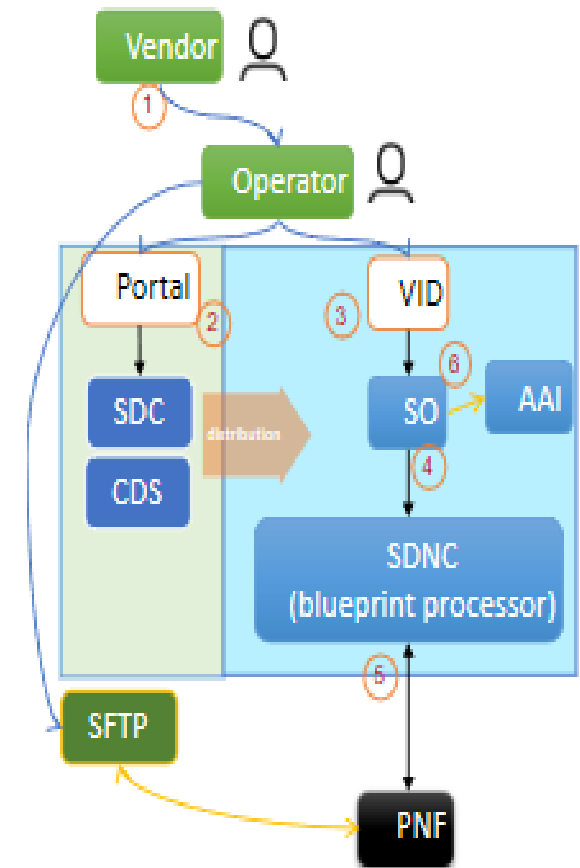

# xNF S/W UPGRADE / with schema update in R7 Guilin

Support xNF Software Upgrade in association to schema update

A schema update in relation to a xNF software upgrades is a routine for network upgrade to support new xNF features, improve efficiency or increase xNF capacity on the field, and to eliminate bugs. This use case provides to ONAP an advantage in orchestrating and managing the Life Cycle of a Network Services in-line with business and service objectives

Key Contacts: Zu Qiang (Ericsson), Lukasz Rajewski (Orange), Ajay Mahimkar (AT&T), Chris Rapposelli-Manzo

<https://wiki.onap.org/pages/viewpage.action?pageId=81400388>

## R7 CANDIDATE ENHANCEMENTS

## IMPACT

### SDC

Updating the xNF resource template from a vendor provided new onboarding package

### SO

Introducing a new service level workflow

- Upgrading a service instance and its resource instances based on the updated templates
- Updating the xNF schema (e.g. software version, artifacts) at xNF instance software upgrade completion
- Updating the network service schema at network service upgrade completion



# CERTIFICATE MANAGEMENT PROTOCOL CMPv2

# CERTIFICATE MANAGEMENT PROTOCOL (CMPv2)

Req Use Case - DESCRIPTION

The Certificate Management Protocol (CMP) is an Internet protocol used for obtaining X.509 digital certificates in a public key infrastructure (PKI). It is described in RFC 4210 and is one of two protocols so far to use the Certificate Request Message Format (CRMF), described in RFC 4211, with the other protocol being Certificate Management over CMS (CMC), described in RFC 5273. An obsolete version of CMP is described in RFC 2510, the respective CRMF version in RFC 2511. CMP messages are encoded in ASN.1, using the DER method and usually transported over HTTP. CMP (Certificate Management Protocol) Server & Client (completed in R6)

## ARCHITECTURE REQUIREMENT IDENTITY – ROW 18

[AR-0017-R7-052020 Guilin release - functional requirements proposed list#R7ONAPSECURITY-CMPv2SERVER/CLIENTINTEGRATION](#) Benjamin Cheung, Pawel Baniewski, Hampus Tjäder [xNF](#)

BUSINESS DRIVERS

**EXECUTIVE SUMMARY** - This requirement improves ONAP Security with CMPv2. CMP is used by multiple operations including Plug and Play, and NetConf operation. In R6 CMPv2 Certificate Service and basic development was implemented. Integration with server & client to the certificate service will be completed. There are also two ONAP bordering clients to integrate with the certificate service with interfaces to (SDN-C = Done) and DCAE. DCAE interoperation with CMPv2. REQ-140

**BUSINESS IMPACT** - The enhancement to CMPv2 operation will improve security management within ONAP and affects multiple ONAP functions and use cases, including Plug and Play (PNF registration) and NetConf. As with all security functionality within ONAP, Security is a fundamental aspect of FCAPS, being the "S" for security management.

**BUSINESS MARKETS** - This project applies to any domain (wireless, transport, optical, and wireline) that ONAP may manage.

**FUNDING/FINANCIAL IMPACTS** - Potential OPEX savings with enhanced security to prevent breaches and prevent security compromises.

**ORGANIZATION MGMT, SALES STRATEGIES** - There is no additional organizational management or sales strategies for this use case outside of a service providers "normal" ONAP deployment and its attendant organizational resources from a service provider.



# CERTIFICATE MANAGEMENT PROTOCOL (CMPv2)

CMP in the TCP/IP model:

|             |          |                 |            |      |    |
|-------------|----------|-----------------|------------|------|----|
| application | CMP      | CMP             |            |      |    |
|             |          | HTTP            | HTTPS      | SMTP | .. |
| transport   |          | TCP             |            |      |    |
| Internet    |          | IP (IPv4, IPv6) |            |      |    |
| link        | Ethernet | Token Bus       | Token Ring | FDDI | .. |

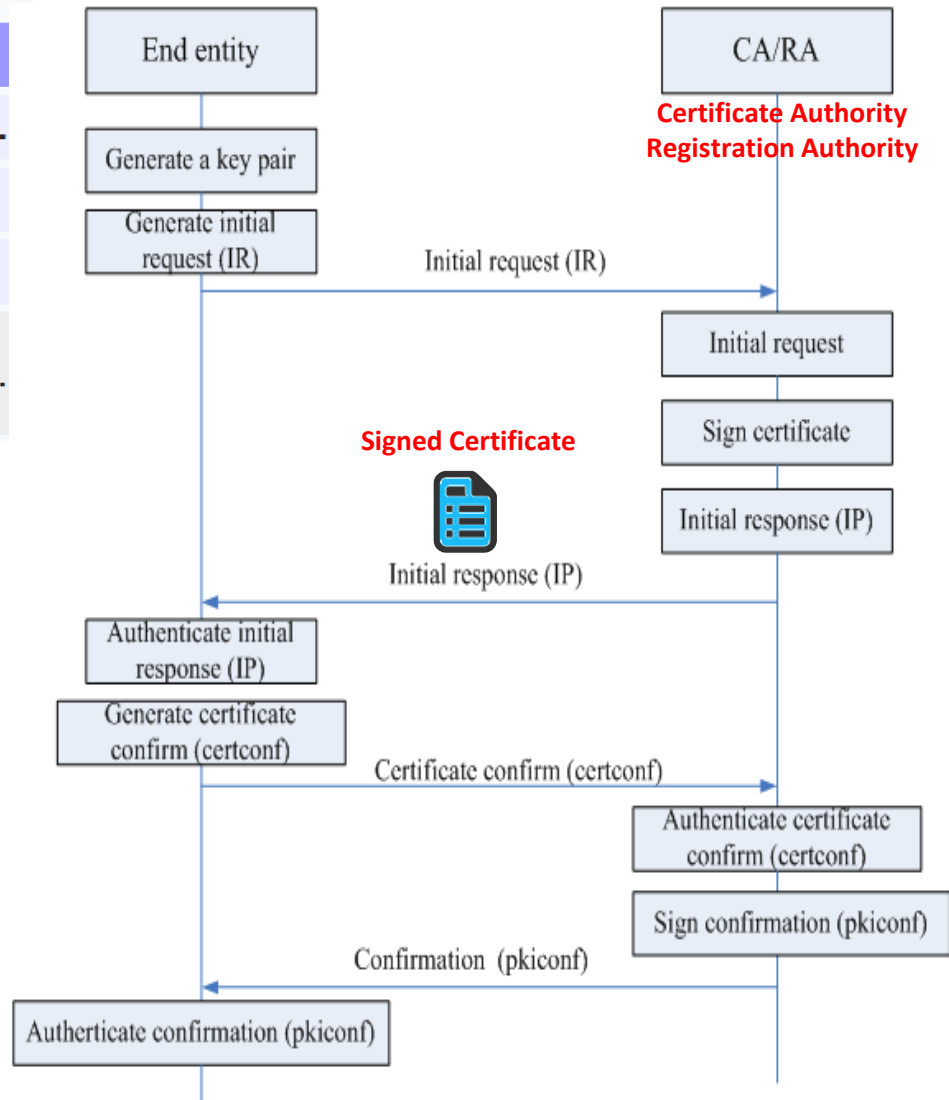

# CMP v2 for R7 Guilin

Wiki

<https://wiki.onap.org/pages/viewpage.action?pageId=84640858>

R7 Guilin NEW COMPONENT CAPABILITIES

## R7 NEW COMPONENT CAPABILITIES

## IMPACT DESCRIPTION

CMP v2 enhancements

CMPv2 Client-Server was done in R6 (Nokia) Integration of bordering ONAP components – DCAE Enhancements in certificate in CMPv2:

- (a) DCAE team requests output artifacts should be configurable (P12, PEM)
- (b) Certificate renewal (Best effort)

**DCAE MOD** - Work Internal to DCAE. Component specifications modified to accommodate parameters to execute the client, with certificate details. In DCAE changed deploying applications collectors, servers, analytics – understood by DCAE only, cloudify blueprint created and DMaaP configuration to deploy the service and connected w/ DMaaP topic. JSON/YAML internally to DCAE. Micro-service onboarding artifact. DCAE Micro service onboarding and design (MOD). Cloudify Manager (Development)

Cert Service Client (Development).

CMP v2 integration/testing

(Ericsson) SDN-C Integration underway already in R6 (**may** have spill over in R7)

# CMP v2 INTERFACES & APIs

## R7 Guilin Interfaces Impacts

| R7 Interfaces | IMPACT  |
|---------------|---|
| CMP v2        | DCAE will have I/F from CertMan (internal tool) instead of AAF. |
|               |   |

## R7 Guilin APIs Impacts

| R7 API | IMPACT                               |
|--------|--------------------------------------|
| CMP v2 | New endpoint for Certificate Update. |
|        |                                      |

# CMP v2 MODELING IMPACTS

R7 Guilin Modeling Impacts

| R7 Model | IMPACT |
|----------|--------|
| (None)   | (None) |
|          |        |