

Accelerating 5G Slicing Deployment via Open Source and Open Standards

ONAP-based 5G slice management survey and proposal

Lingli Deng, China Mobile

2019.09@ONS-EU

Outline

- 5G slice mgmt architecture and related standards
- ONAP-based slice management solutions/PoCs
- Proposals for community use-case working plan

Related industry organizations

- **3GPP SA5 defines functional architecture & information model for 5G Slicing Mgmt**
 - TR28.801 and TR28.805 define the functional architecture of slice management.
 - TS28.531 is developing slice management information models and interaction workflows.
 - **Not planning to further specify related interfaces.**
- **TMF openAPI defines CFS/RFS management interface specifications**
 - It provides reference recommendation for slice management based on ODA.
 - It defines the openAPI standards for service management (incl. CFS and RFS).
- **GSMA NEST develops slice template and standard slice type (Overlaps with 3GPP)**
 - It is developing general slice template GST and slice type NEST.
 - It plans to develop a cross-operator standard slice template named S-NEST.
- **ETSI NFV defines partially (i.e. the NFV domain) resource mgmt interfaces**
 - It defines the MANO functional architecture and related interface specifications in virtualized network resource management domain.
- **LFN ONAP implements the support of service management and resource management functions with standard interface compliance**
 - externalAPI implements openAPI of TMF service management.
 - SDC、SO/VF-C implements cross-domain and/or NFV resource management functions with compliant ETSI MANO interfaces.
 - 5G Slicing Mgmt is part of the community 5G use-case under development.

5G slice mgmt functional architecture (1/2)

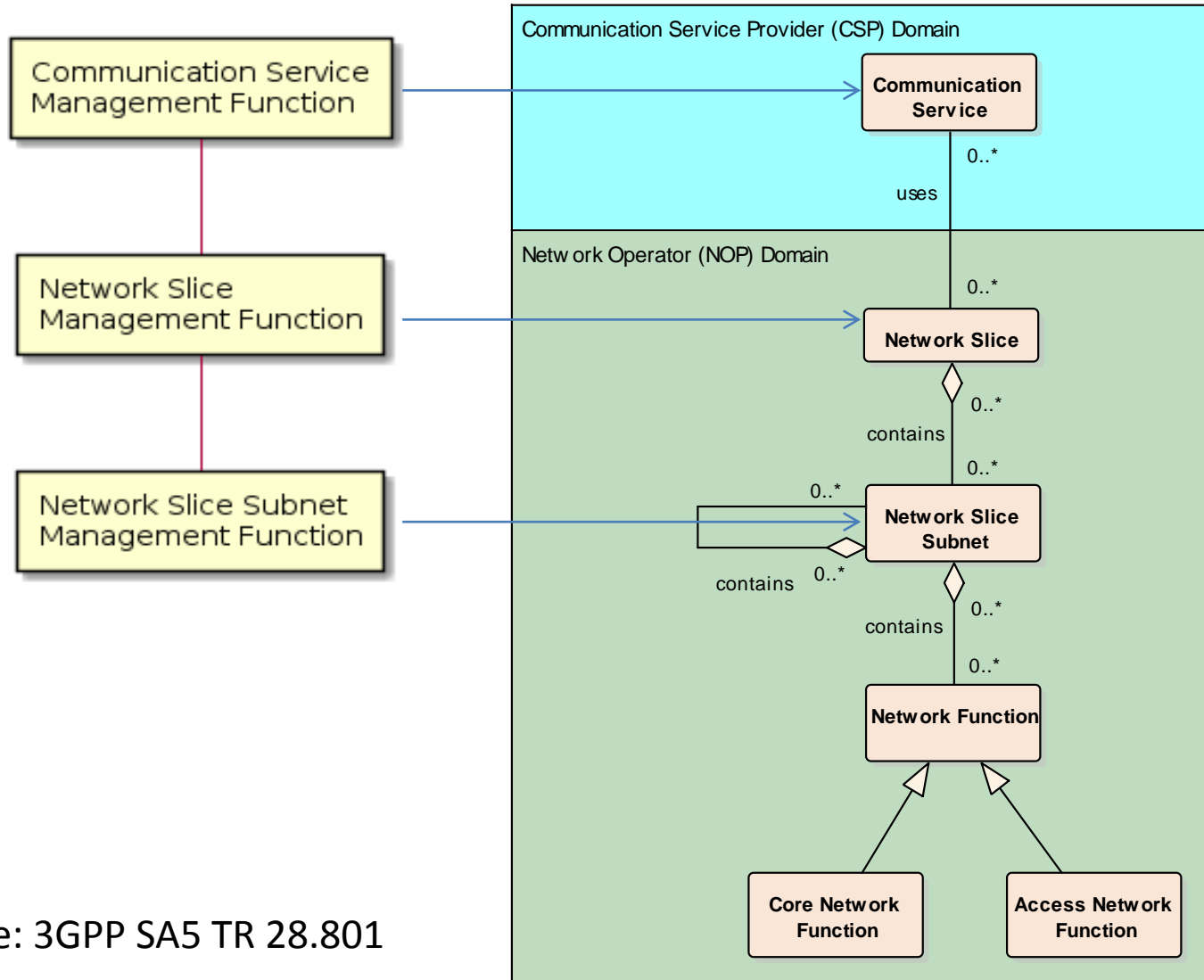

Source: 3GPP SA5 TR 28.801

5G slice mgmt functional architecture (2/2)

Taken into consideration of the two-layer service management functional division of CSMF, the slice management architecture can be further divided into four levels.

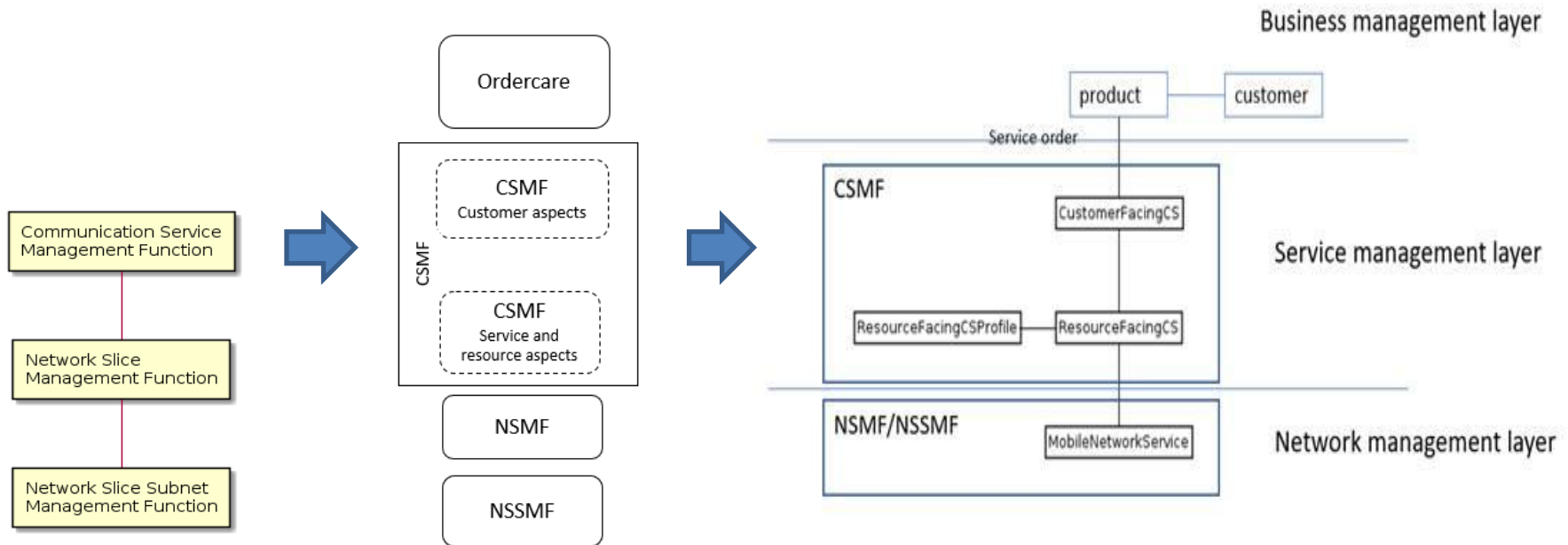

Source: 3GPP SA5 TR 28.805

Slice mgmt solution classification

Mode 1: Three-layers mode

- Provides different functional layers with different software combinations.
- There are several non-standard interfaces, hence difficult to deploy.

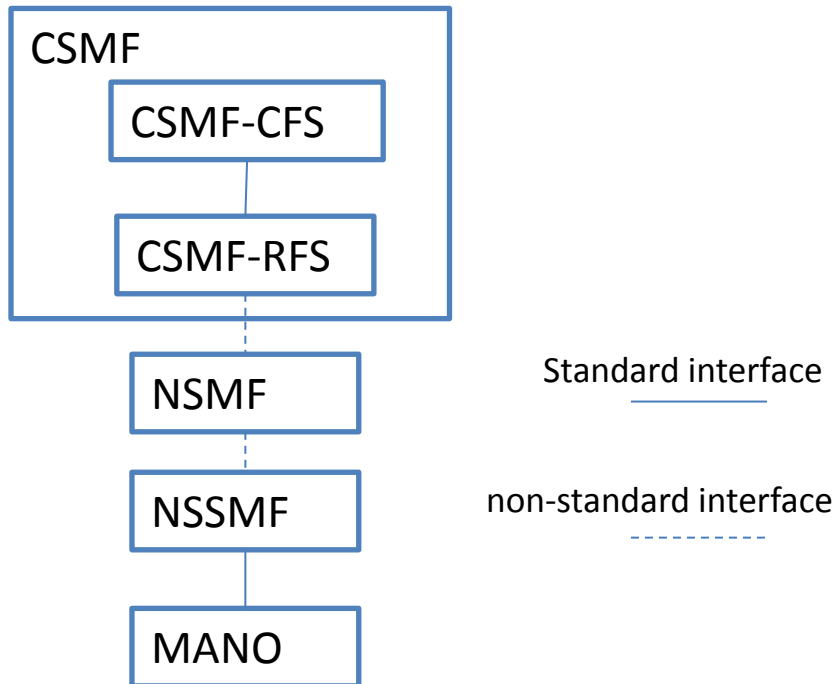

Mode 2: Two-layers mode

- It divides and combines CSMF functions with NSMF and NSSMF, using TMF openAPIs in between.
- It is based on standard interface, easy to deploy.

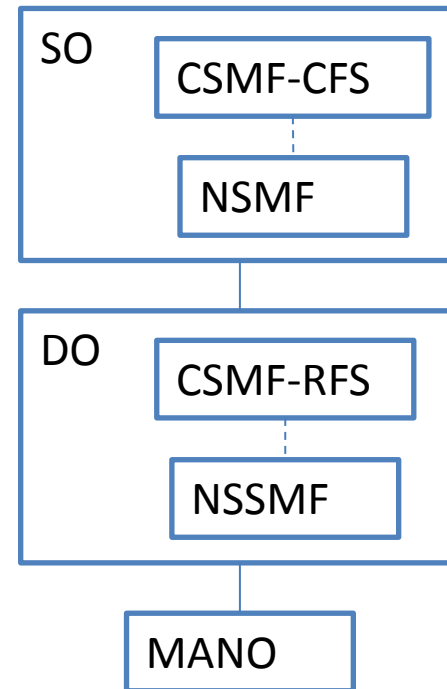

Mode 3: One-layer mode (Full stack mode)

- All functions of CSMF+NSMF+NSSMF are provided by a single piece of software.

Outline

- 5G slice mgmt architecture and related standards
- ONAP-based slice management solutions/PoCs
- Proposals for community use-case working plan

ONAP Based PoC #1

Mode 1: CSMF-RFS

Solution Architecture relative to Open Digital Architecture (ODA)

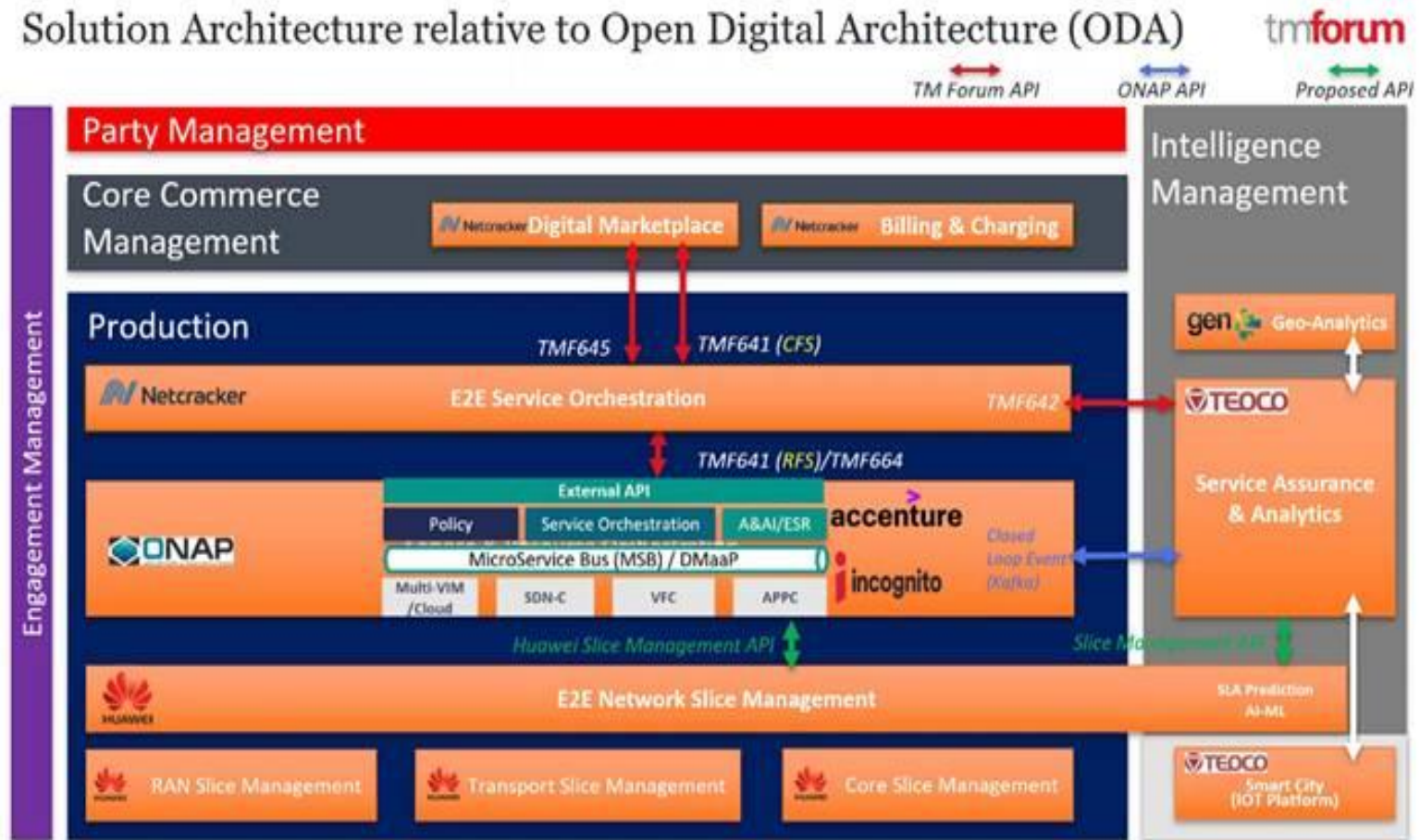

Source: TMF DTW 2019 Catalyst - 5G Riders on the Storm

ONAP Based PoC #2

Mode 2: DO (RFS+NSSMF)

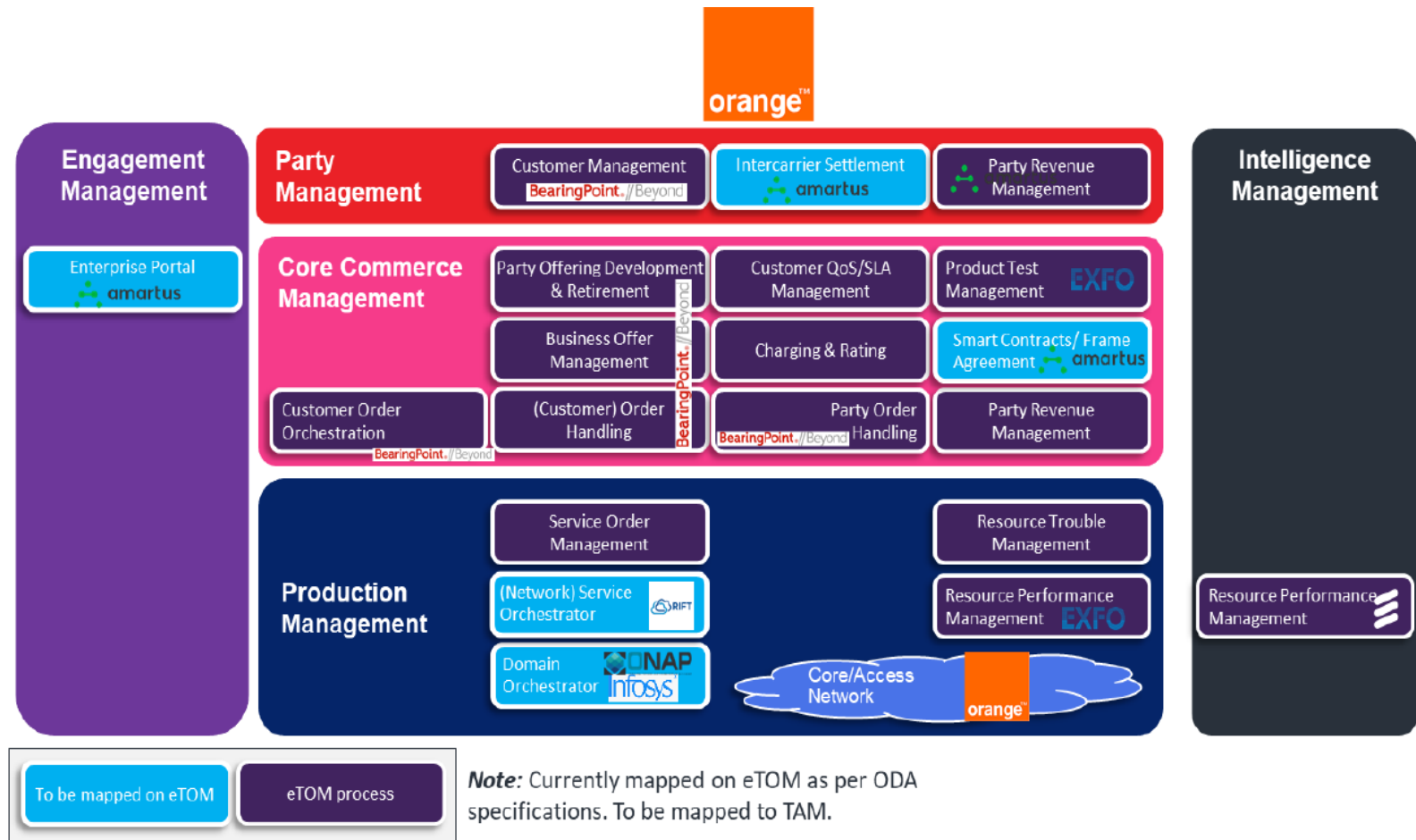

Source: TMF DTW 2019 Catalyst - Skynet

ONAP Based PoC #3

Mode 3: SO+DO/Mode 3

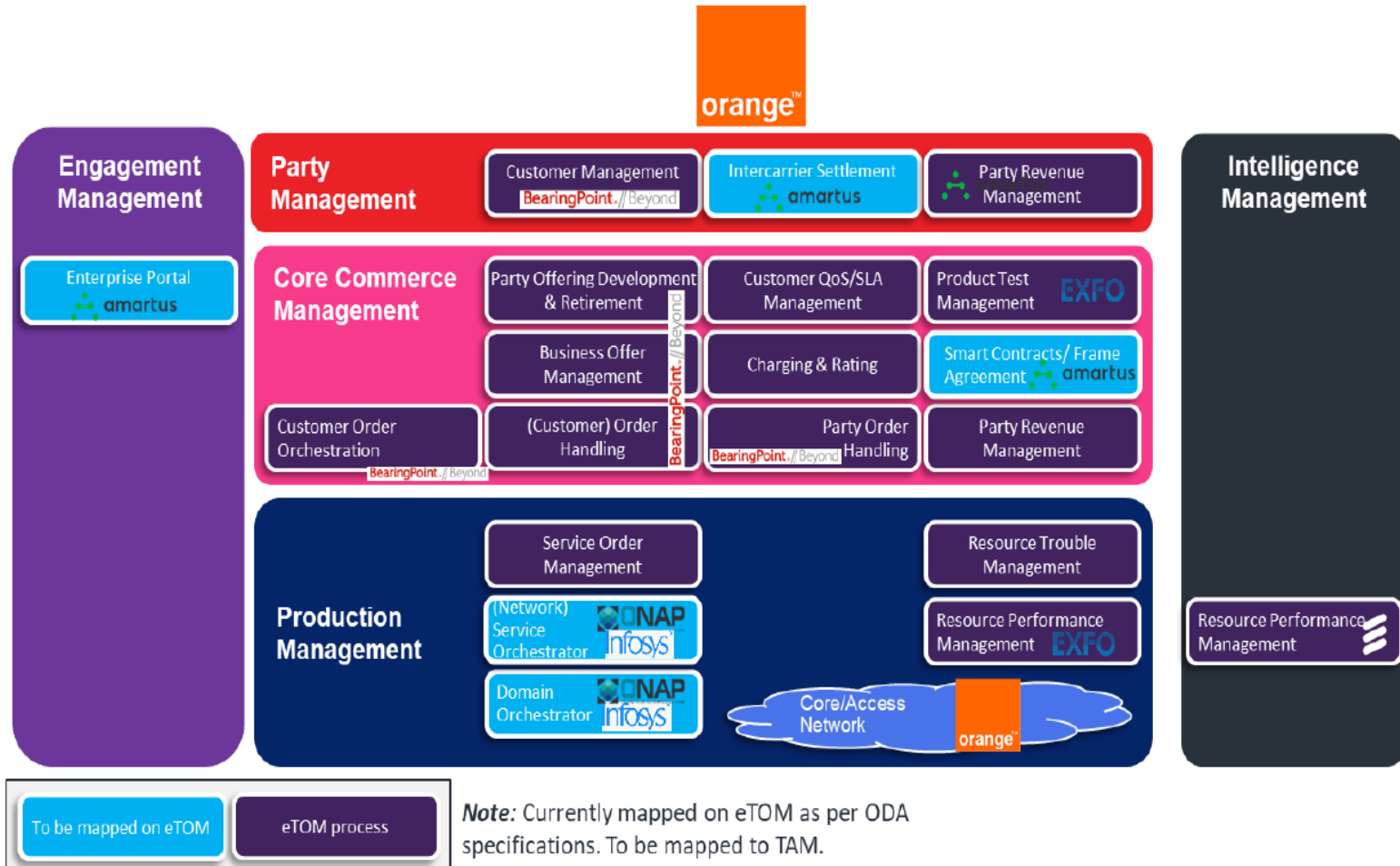

Source: TMF DTW 2019 Catalyst - Skynet

Outline

- 5G slice mgmt architecture and related standards
- ONAP-based slice management solutions/PoCs
- **Proposals for community use-case working plan**

ONAP Community PoC Proposal

Existing Track: Bottom UP

Slicing Mgmt as part of the 5G use-case

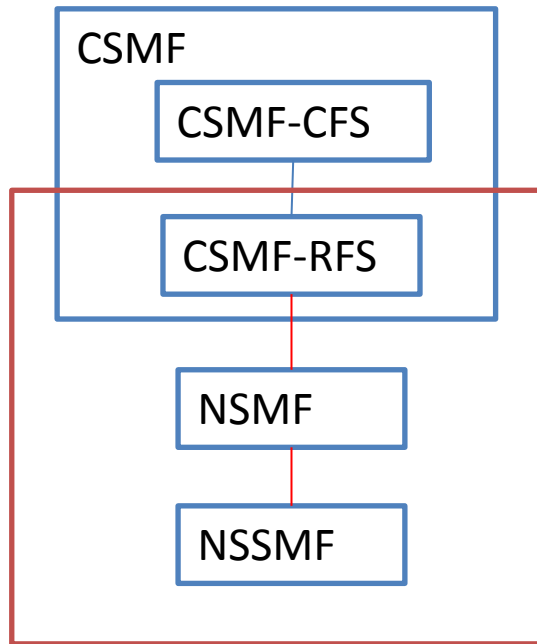

Proposed Track: Top Down

CSMF-RFS addition to the existing track

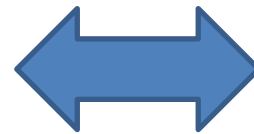
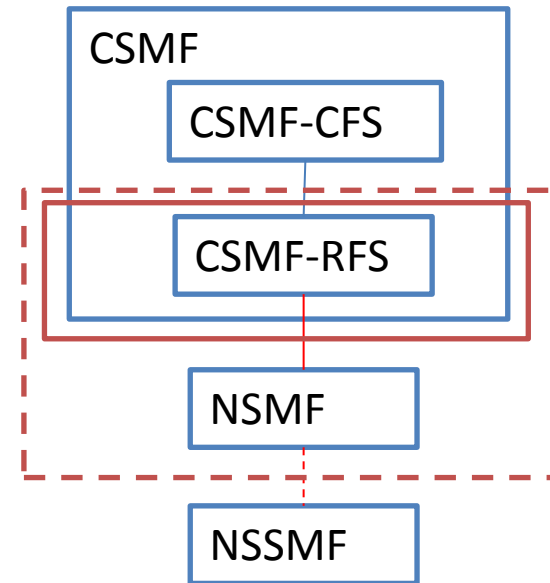

Complementary
to each other

- Seek to implements full stack solution using ONAP.
- Use community to decouple all layers of interfaces.
- Adopting a bottom-up working plan.
- The design is delayed by lower-level resource mgmt orchestration, i.e. Alloted resource, etc.

- The top-down push strategy is used to implement the reference implementation of each layer step by step
- Ease for quick integration and verification with existing commercial solutions on the market.

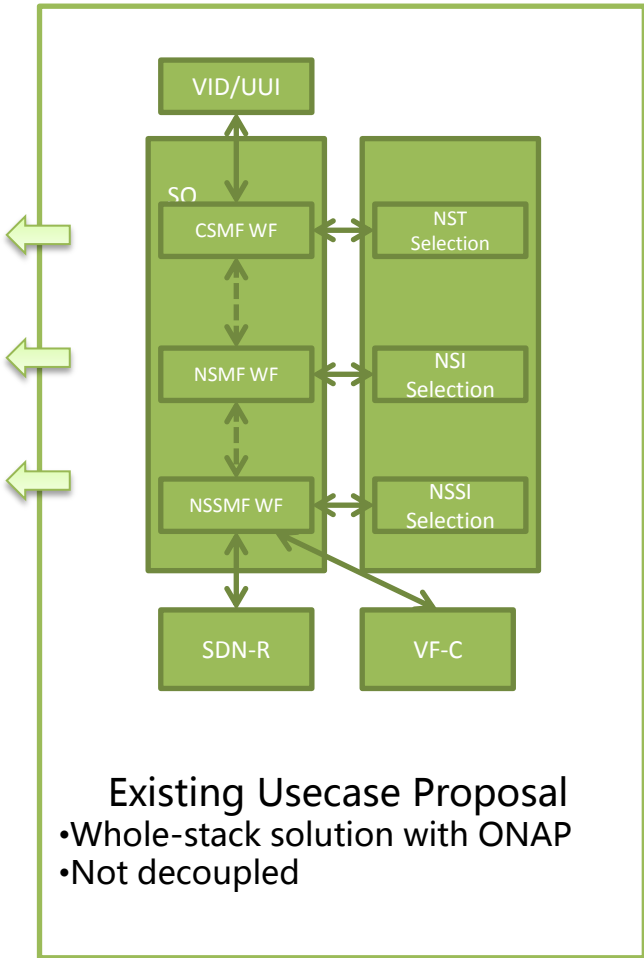
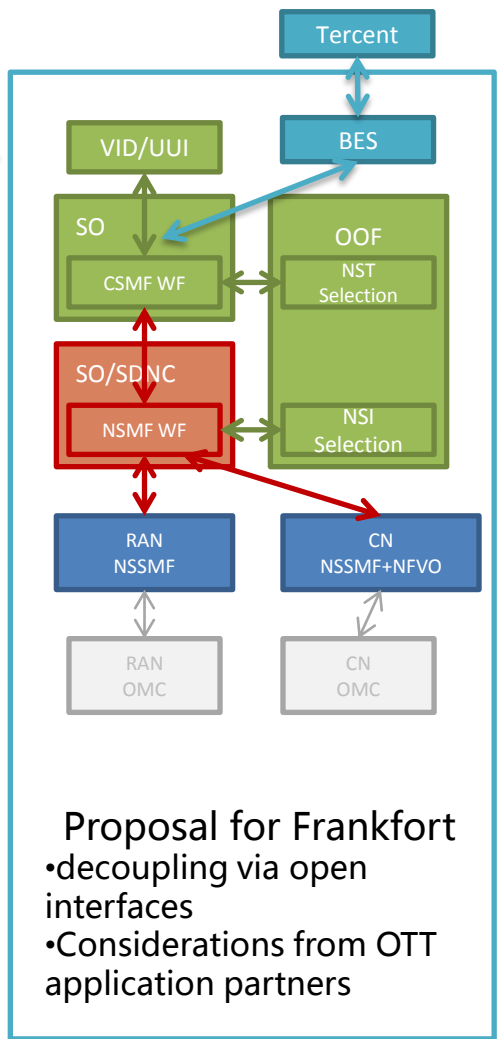
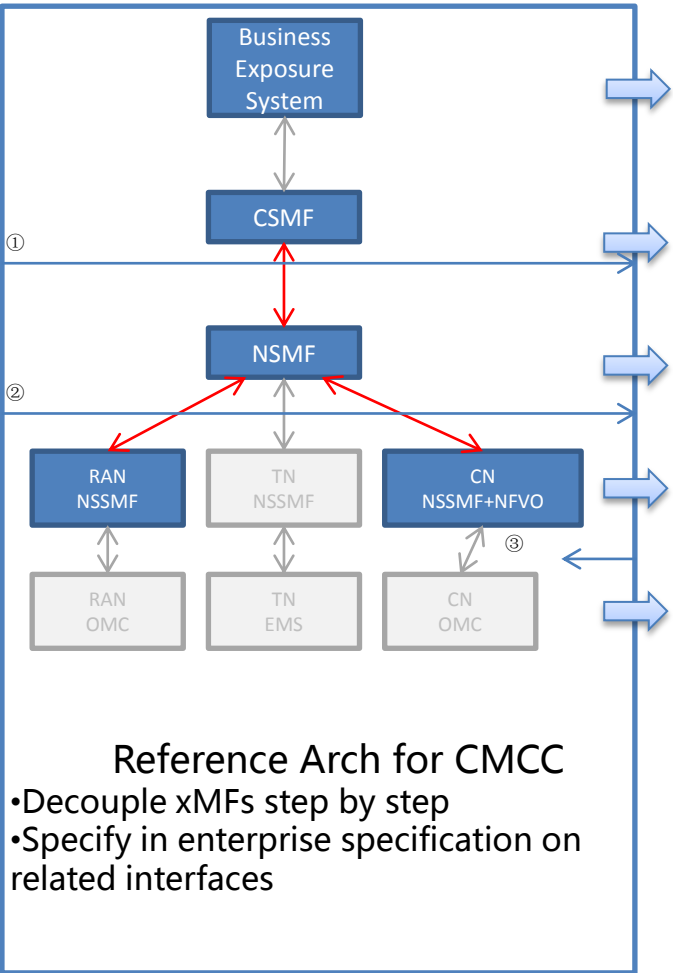

Follow-up suggestions

- Accelerating community PoC development for 5G Slicing Mgmt
 - Initiating the top-down slice management PoC development track.
 - Coordinated with the existing complementary work to form collaboration, not competition.
- Strengthen coordination between standards and community
 - Slice management architecture: 3GPP SA5
 - Slice management intelligent network element:
(overlapping parallel threads, needs coordination)
 - 3GPP SA2 NWDAF intelligent slice management
 - 3GPP SA5 MDAF intelligent slice management
 - Slice management interface: TMF openAPI/ODA
 - Slice templates: 3GPP SA5/GSMA NEST

Goal

Accelerate the specification development and improve interoperability between vendor solutions for 5G slicing management, via providing reference implementation in LFN community.

Scope

- Provide the prototype of CSMF and NSMF with ONAP.
- Verify commercial interoperability by interworking with vendors' NSMF/NSSMF.
- Open service creation and performance monitoring towards 3rd party service operator on the top.

On-demand 5G Slice w. ONAP

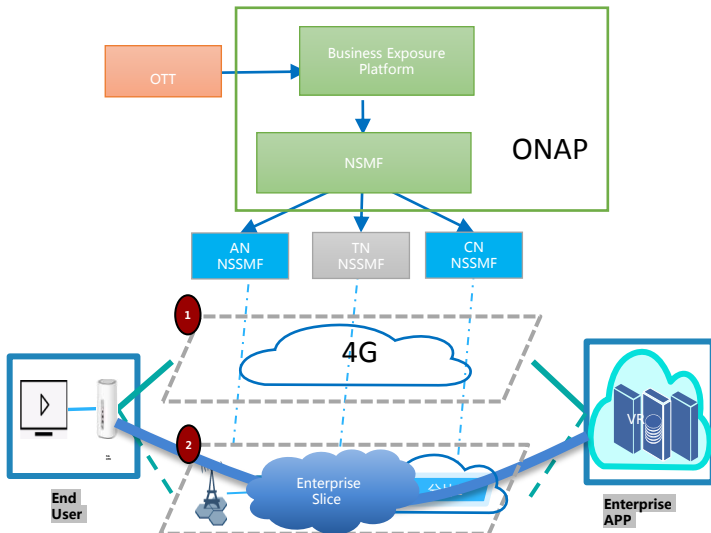

Demo

- Expose **Service Order** and **Creation Policy** interfaces to Tencent App
- Realize **partial CSMF/NSMF** with SO/SDNC
- Integrate with Vendor NSSMF and **Commercial 5G RAN/Core**

Follow-ups

- NST/NSST template specification
- Support NSST onboarding and NST design in SDC
- E2E NST orchestration in SO/SDN-C
- Support NST and NSI selection in OOF

LFN Booth: OVP in Action

Goal

Accelerate operators and vendors to build open ecosystems such as 5G+AI and 5G+ Edge, via providing OVP-based NFV automated testing tools and VNF certified store.

Scope

- Provide the end-to-end testing reference flow and framework based on open source component.
- Test process tracking and results feedback
- Flexible test case injection and third-party system integration capabilities

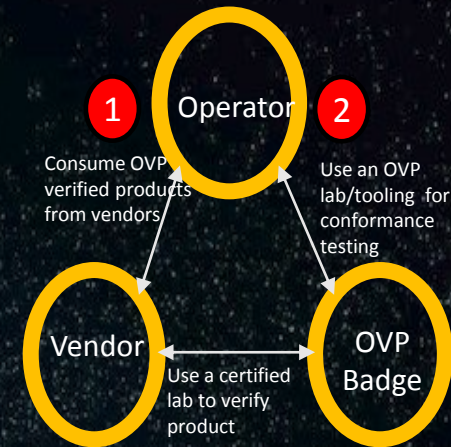

Tosca VNF Validation on ONAP

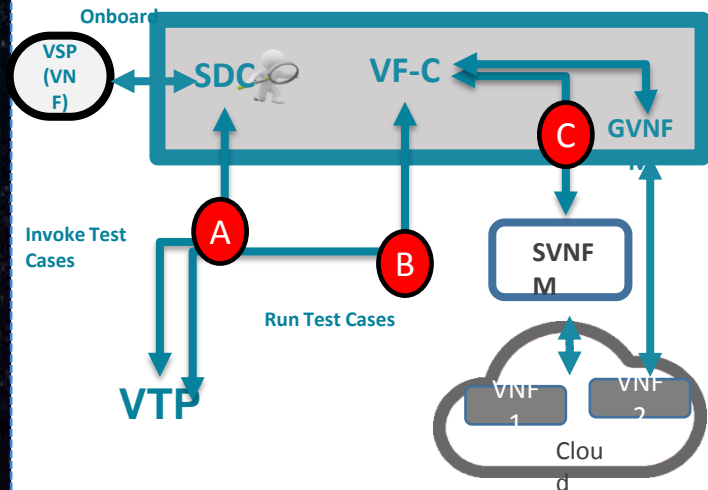

Demo

- Tosca VNF Compliance testing with VNF SDK
- Tosca VNF Validation testing with VF-C
- Testing steps monitoring and tracking with VTP

Follow-ups

- Support VNF function and performance testing
- Pluggable test framework for more testing , e.g. interoperability
- Layered badging program to allow differentiated conformance

Goal

To enable flexible customization, on-demand deployment and capability sharing of network oriented analytic applications via a general network intelligent operation and maintenance software stack, including network data collection, persistence and analytics.

Scope

- Introduce on-demand, persistent of cross-layer network data storage to ONAP
- Extend ONAP DaaS, SDC, SO module to support analysis layer service design/sharing
- Encapsulate traffic prediction models with Acumos and integrate into ONAP

Demo

- Data persistence and visualization with Datalake
- Analytics model training , deployment and mgmt with DaaS
- Augmented scaling based on traffic prediction model with SO

Follow-ups

- Expand DCAE to support big data storage and DaaS docking
- Encapsulate prediction micro-service with Acumos
- Extended SDC to support design with shared AI micro-service
- Integrate with OVP program

